



www.cbateknoloji.com



LED AYDINLATMA
KATALOĐU

2





LED AYDINLATMA KATALOĐU

2



İçindekiler

Led Projektörler.....	1
Led Sokak Armatürleri.....	7
Led Tünel Aydınlatmalar.....	14
Wallwasherlar.....	15
Kanopiler.....	18
Yüksek Tavan Aydınlatmalar.....	19
Kuyumcu Armatürleri.....	22
Havuz Armatürleri.....	27
Led Ray Spotlar.....	29
Led Linelar.....	31
Led Neonlar.....	32
Sarkıtlar.....	33
Led Bahçe Armatürleri.....	46
Direkli Sokak Aydınlatmalar.....	47
Led Lens Açıları.....	52

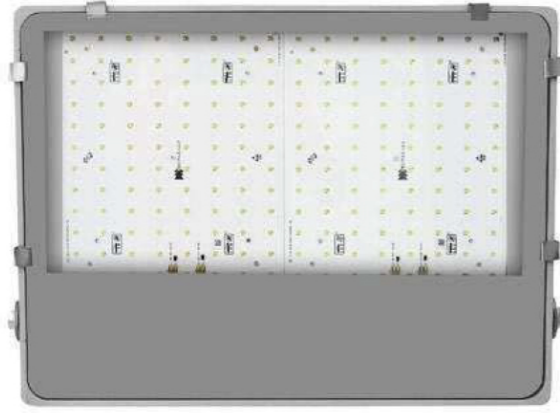
**PHX-1011**

Güç	: 200 W
Çalışma Voltaj	: AC - 110/220V
Işık Akısı	: 35.000 Lümen
Koruma Sınıfı	: IP 65
Montaj Ölçüsü	: 350 x 370 x 200 mm

PHX-1012

Güç	: 300 W
Çalışma Voltaj	: AC - 110/220V
Işık Akısı	: 52.000 Lümen
Koruma Sınıfı	: IP 65
Montaj Ölçüsü	: 350 x 370 x 200 mm

PHX-1013

Güç	: 400 W
Çalışma Voltaj	: AC - 110/220V
Işık Akısı	: 70.000 Lümen
Koruma Sınıfı	: IP 65
Montaj Ölçüsü	: 350 x 370 x 200 mm

PHX-1014

Güç	: 500 W
Çalışma Voltaj	: AC - 110/220V
Işık Akısı	: 87.500 Lümen
Koruma Sınıfı	: IP 65
Montaj Ölçüsü	: 350 x 370 x 200 mm

PHX-1021 Merceкли

Güç	: 120 W
Çalışma Voltaj	: AC - 110/220V
Işık Akısı	: 21.000 Lümen
Koruma Sınıfı	: IP 65
Montaj Ölçüsü	: 500 x 300 x 120 mm

PHX-1023 Merceкли

Güç	: 150 W
Çalışma Voltaj	: AC - 110/220V
Işık Akısı	: 26.500 Lümen
Koruma Sınıfı	: IP 65
Montaj Ölçüsü	: 500 x 300 x 120 mm

PHX-1025 Merceкли

Güç	: 200 W
Çalışma Voltaj	: AC - 110/220V
Işık Akısı	: 35.000 Lümen
Koruma Sınıfı	: IP 65
Montaj Ölçüsü	: 500 x 300 x 120 mm

PHX-1027 Merceкли

Güç	: 250 W
Çalışma Voltaj	: AC - 110/220V
Işık Akısı	: 43.750 Lümen
Koruma Sınıfı	: IP 65
Montaj Ölçüsü	: 500 x 300 x 120 mm

Led
NICHIA PHILIPS SAMSUNG
bridgelux. OSRAM PhonexLed
SMD Power Led, 175 Lümen/W
50.000 Saat Ömür

Led
NICHIA PHILIPS SAMSUNG
bridgelux. OSRAM PhonexLed
SMD Power Led, 175 Lümen/W
50.000 Saat Ömür

Sürücü
PHILIPS TEZRUN MW MEANWELL PhonexLed

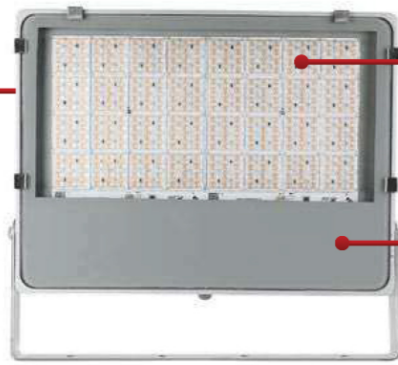

Gövde

Enjeksiyon alüminyum elektostatik boyalı gövde,
4mm tamperli cam ve hareketli montaj ayağı

Sürücü
PHILIPS TEZRUN MW MEANWELL PhonexLed



Gövde

Enjeksiyon alüminyum elektostatik boyalı gövde,
4mm tamperli cam ve hareketli montaj ayağı



**PHX-1021 Merceksiz**

Güç	: 120 W
Çalışma Voltaj	: AC - 110/220V
Işık Akısı	: 21.000 Lümen
Koruma Sınıfı	: IP 65
Montaj Ölçüsü	: 500 x 300 x 120 mm

PHX-1023 Merceksiz

Güç	: 150 W
Çalışma Voltaj	: AC - 110/220V
Işık Akısı	: 26.500 Lümen
Koruma Sınıfı	: IP 65
Montaj Ölçüsü	: 500 x 300 x 120 mm

PHX-1025 Merceksiz

Güç	: 200 W
Çalışma Voltaj	: AC - 110/220V
Işık Akısı	: 35.000 Lümen
Koruma Sınıfı	: IP 65
Montaj Ölçüsü	: 500 x 300 x 120 mm

PHX-1031

Güç	: 60 W
Çalışma Voltaj	: AC - 110/220V
Işık Akısı	: 10.500 Lümen
Koruma Sınıfı	: IP 65
Montaj Ölçüsü	: 510 x 250 x 200 mm

PHX-1033

Güç	: 120 W
Çalışma Voltaj	: AC - 110/220V
Işık Akısı	: 21.000 Lümen
Koruma Sınıfı	: IP 65
Montaj Ölçüsü	: 510 x 250 x 200 mm

PHX-1035

Güç	: 150 W
Çalışma Voltaj	: AC - 110/220V
Işık Akısı	: 26.500 Lümen
Koruma Sınıfı	: IP 65
Montaj Ölçüsü	: 510 x 250 x 200 mm

PHX-1027 Merceksiz

Güç	: 250 W
Çalışma Voltaj	: AC - 110/220V
Işık Akısı	: 43.750 Lümen
Koruma Sınıfı	: IP 65
Montaj Ölçüsü	: 500 x 300 x 120 mm

Led
NICHIA PHILIPS SAMSUNG
bridgelux OSRAM PhonexLed
SMD Power Led, 175 Lümen/W
50.000 Saat Ömür

Led
NICHIA PHILIPS SAMSUNG
bridgelux OSRAM PhonexLed
SMD Power Led, 175 Lümen/W
50.000 Saat Ömür

Sürücü
PHILIPS TEZRUN MW MEANWELL PhonexLed

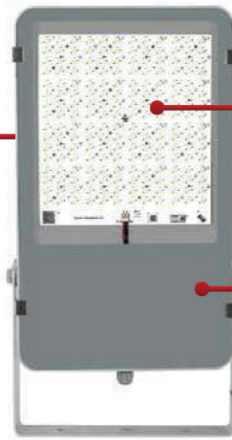

Gövde
Enjeksiyon alüminyum elektrostatik boyalı gövde,
4mm tamperli cam ve hareketli montaj ayağı

Sürücü
PHILIPS TEZRUN MW MEANWELL PhonexLed



Gövde
Enjeksiyon alüminyum elektrostatik boyalı gövde,
4mm tamperli cam ve hareketli montaj ayağı

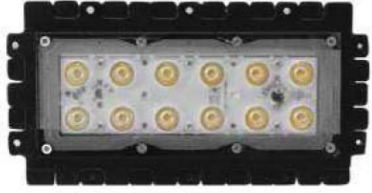

**PHX-1050**

Güç	: 50 W
Çalışma Voltaj	: AC - 110/220V
Işık Akısı	: 8.750 Lümen
Koruma Sınıfı	: IP 65
Montaj Ölçüsü	: 210 x 110 x 100 mm

**PHX-1050/2**

Güç	: 100 W
Çalışma Voltaj	: AC - 110/220V
Işık Akısı	: 17.500 Lümen
Koruma Sınıfı	: IP 65
Montaj Ölçüsü	: 210 x 210 x 150 mm

**PHX-1050/4**

Güç	: 200 W
Çalışma Voltaj	: AC - 110/220V
Işık Akısı	: 35.000 Lümen
Koruma Sınıfı	: IP 65
Montaj Ölçüsü	: 210 x 410 x 330 mm

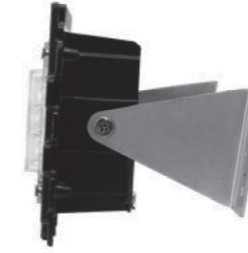

Led
NICHIA PHILIPS SAMSUNG
 bridgelux. **OSRAM** PhonexLed
 SMD Power Led, 175 Lümen/W
 50.000 Saat Ömür

Sürücü
PHILIPS **TEKRUN** **MW** **MEANWELL** PhonexLed

Gövde

Enjeksiyon alüminyum elektrostatik boyalı gövde,
 4mm tamperli cam ve hareketli montaj ayağı

**PHX-1050/8**

Güç	: 400 W
Çalışma Voltaj	: AC - 110/220V
Işık Akısı	: 70.000 Lümen
Koruma Sınıfı	: IP 65
Montaj Ölçüsü	: 420 x 410 x 330 mm

**PHX-1050/16**

Güç	: 800 W
Çalışma Voltaj	: AC - 110/220V
Işık Akısı	: 140.000 Lümen
Koruma Sınıfı	: IP 65
Montaj Ölçüsü	: 420 x 820 x 330 mm

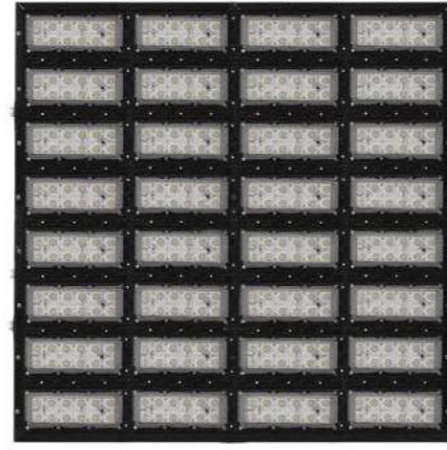
**PHX-1050/32**

Güç	: 1600 W
Çalışma Voltaj	: AC - 110/220V
Işık Akısı	: 280.000 Lümen
Koruma Sınıfı	: IP 65
Montaj Ölçüsü	: 840 x 820 x 330 mm



Uzun
Ömürlü



Enerji
Tasarrufu



Çevre
Dostu



Kolay
Montaj



Yapı
Bütünlüğü



Topraklama



Kalite
Belgesi



ENEC
Sertifika



ATEX
Sertifika



RoHS
Sertifika



Kasa Rengi
Değişebilir

**PHX-1020 Merceкли**

Güç	: 60 W
Çalışma Voltaj	: AC - 110/220V
Işık Akısı	: 10.500 Lümen
Koruma Sınıfı	: IP 65
Montaj Ölçüsü	: 500 x 300 x 120 mm

PHX-1022 Merceкли

Güç	: 80 W
Çalışma Voltaj	: AC - 110/220V
Işık Akısı	: 14.000 Lümen
Koruma Sınıfı	: IP 65
Montaj Ölçüsü	: 500 x 300 x 120 mm

PHX-1024 Merceкли

Güç	: 100 W
Çalışma Voltaj	: AC - 110/220V
Işık Akısı	: 17.500 Lümen
Koruma Sınıfı	: IP 65
Montaj Ölçüsü	: 500 x 300 x 120 mm

PHX-1020 Merceksiz

Güç	: 60 W
Çalışma Voltaj	: AC - 110/220V
Işık Akısı	: 10.500 Lümen
Koruma Sınıfı	: IP 65
Montaj Ölçüsü	: 500 x 300 x 120 mm

PHX-1022 Merceksiz

Güç	: 80 W
Çalışma Voltaj	: AC - 110/220V
Işık Akısı	: 14.000 Lümen
Koruma Sınıfı	: IP 65
Montaj Ölçüsü	: 500 x 300 x 120 mm

PHX-1024 Merceksiz

Güç	: 100 W
Çalışma Voltaj	: AC - 110/220V
Işık Akısı	: 17.500 Lümen
Koruma Sınıfı	: IP 65
Montaj Ölçüsü	: 500 x 300 x 120 mm



**PHX-1032**

Güç	: 60 W
Çalışma Voltaj	: AC - 110/220V
Işık Akısı	: 10.500 Lümen
Koruma Sınıfı	: IP 65
Montaj Ölçüsü	: 510 x 260 x 55 mm

PHX-1034

Güç	: 120 W
Çalışma Voltaj	: AC - 110/220V
Işık Akısı	: 21.000 Lümen
Koruma Sınıfı	: IP 65
Montaj Ölçüsü	: 510 x 260 x 55 mm

PHX-1036

Güç	: 150 W
Çalışma Voltaj	: AC - 110/220V
Işık Akısı	: 26.250 Lümen
Koruma Sınıfı	: IP 65
Montaj Ölçüsü	: 510 x 260 x 55 mm

PHX-1040

Güç	: 30 W
Çalışma Voltaj	: AC - 110/220V
Işık Akısı	: 5.250 Lümen
Koruma Sınıfı	: IP 65
Montaj Ölçüsü	: 510 x 260 x 55 mm

Led
NICHIA PHILIPS SAMSUNG
bridgelux OSRAM PhonexLed
SMD Power Led, 175 Lümen/W
50.000 Saat Ömür

Sürücü
PHILIPS TEZRUN MW MEANWELL PhonexLed



Gövde
Enjeksiyon alüminyum elektrostatik boyalı gövde,
4mm tıparırlı cam ve hareketli montaj ayağı

Led
NICHIA PHILIPS SAMSUNG
bridgelux OSRAM PhonexLed
SMD Power Led, 175 Lümen/W
50.000 Saat Ömür

Sürücü
PHILIPS TEZRUN MW MEANWELL PhonexLed

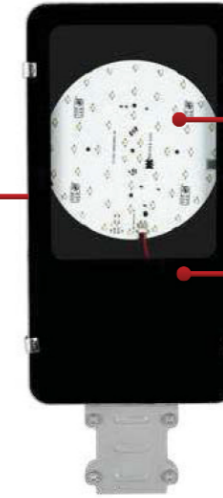

Gövde
Enjeksiyon alüminyum elektrostatik boyalı gövde,
4mm tıparırlı cam ve hareketli montaj ayağı

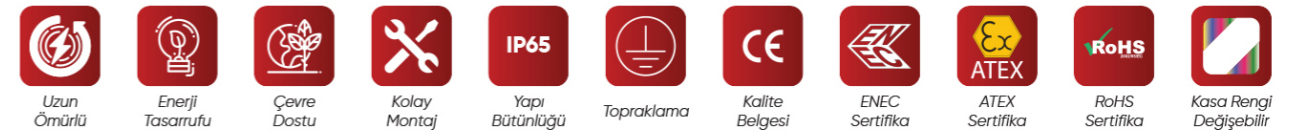



48'lik

60'lik

PHX-1044/60

Güç	: 60 W
Çalışma Voltaj	: AC - 110/220V
Işık Akısı	: 10.500 Lümen
Koruma Sınıfı	: IP 65
Montaj Ölçüsü	: 240 x 470 x 250 mm

PHX-1044/100

Güç	: 100 W
Çalışma Voltaj	: AC - 110/220V
Işık Akısı	: 17.500 Lümen
Koruma Sınıfı	: IP 65
Montaj Ölçüsü	: 240 x 470 x 250 mm

PHX-1044/120

Güç	: 120 W
Çalışma Voltaj	: AC - 110/220V
Işık Akısı	: 21.000 Lümen
Koruma Sınıfı	: IP 65
Montaj Ölçüsü	: 240 x 470 x 250 mm



48'lik

60'lik

PHX-1044/60-COB

Güç	: 60 W
Çalışma Voltaj	: AC - 110/220V
Işık Akısı	: 10.500 Lümen
Koruma Sınıfı	: IP 65
Montaj Ölçüsü	: 240 x 470 x 250 mm

PHX-1044/80-COB

Güç	: 80 W
Çalışma Voltaj	: AC - 110/220V
Işık Akısı	: 14.000 Lümen
Koruma Sınıfı	: IP 65
Montaj Ölçüsü	: 240 x 470 x 250 mm

PHX-1044/150

Güç	: 150 W
Çalışma Voltaj	: AC - 110/220V
Işık Akısı	: 26.250 Lümen
Koruma Sınıfı	: IP 65
Montaj Ölçüsü	: 240 x 470 x 250 mm

Led
NICHIA PHILIPS SAMSUNG
bridgelux OSRAM PhonexLed
SMD Power Led, 175 Lümen/W
50.000 Saat Ömür

Sürücü
PHILIPS TEZRUN MW MEANWELL PhonexLed



Gövde

Enjeksiyon alüminyum elektrostatik boyalı gövde,
4mm tamperli cam ve hareketli montaj ayağı



Led
NICHIA PHILIPS SAMSUNG
bridgelux OSRAM PhonexLed
SMD Power Led, 175 Lümen/W
50.000 Saat Ömür

Sürücü
PHILIPS TEZRUN MW MEANWELL PhonexLed



Gövde

Enjeksiyon alüminyum elektrostatik boyalı gövde,
4mm tamperli cam ve hareketli montaj ayağı

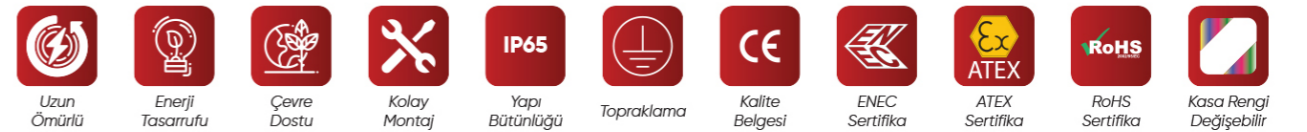



PHX-1028/60 Merceklil/Merceksiz

Güç	: 60 W
Çalışma Voltaj	: AC - 110/220V
Işık Akısı	: 10.500 Lümen
Koruma Sınıfı	: IP 65
Montaj Ölçüsü	: 270 x 420 x 50 mm

PHX-1028/80 Merceklil/Merceksiz

Güç	: 80 W
Çalışma Voltaj	: AC - 110/220V
Işık Akısı	: 14.000 Lümen
Koruma Sınıfı	: IP 65
Montaj Ölçüsü	: 270 x 420 x 50 mm

PHX-1028/100 Merceklil/Merceksiz

Güç	: 100 W
Çalışma Voltaj	: AC - 110/220V
Işık Akısı	: 17.500 Lümen
Koruma Sınıfı	: IP 65
Montaj Ölçüsü	: 270 x 420 x 50 mm

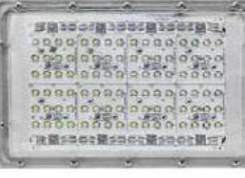

PHX-1041 (Her Bir Modül)

Güç	: 100 W
Çalışma Voltaj	: DC - 110/220V
Işık Akısı	: 17.500 Lümen
Koruma Sınıfı	: IP 65
Montaj Ölçüsü	: 180 x 300 x 170 mm

PHX-1041 (Her Bir Modül)

Güç	: 150 W
Çalışma Voltaj	: DC - 110/220V
Işık Akısı	: 26.250 Lümen
Koruma Sınıfı	: IP 65
Montaj Ölçüsü	: 180 x 300 x 170 mm

Led
NICHIA PHILIPS SAMSUNG
bridgelux. OSRAM PhonexLed
SMD Power Led, 175 Lümen/W
50.000 Saat Ömür

Sürücü
PHILIPS TEX RUN MW MEANWELL PhonexLed



Gövde
Enjeksiyon alüminyum elektrostatik boyalı gövde,
4mm tamperli cam ve hareketli montaj ayağı

Led
NICHIA PHILIPS SAMSUNG
bridgelux. OSRAM PhonexLed
SMD Power Led, 175 Lümen/W
50.000 Saat Ömür

Sürücü
PHILIPS TEX RUN MW MEANWELL PhonexLed



Gövde
Ekstrüzyon alüminyum eloksallı kaplamalı gövde,
polikarbon kapak

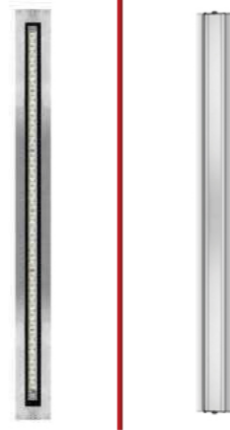

**PHX-1045/A3**

Güç	: 3 W
Çalışma Voltaj	: AC - 110/220V
Işık Akısı	: 525 Lümen
Koruma Sınıfı	: IP 65
Montaj Ölçüsü	: 58 x 96 x 58 mm

PHX-1045/A6

Güç	: 6 W
Çalışma Voltaj	: AC - 110/220V
Işık Akısı	: 1.050 Lümen
Koruma Sınıfı	: IP 65
Montaj Ölçüsü	: 58 x 176 x 58 mm

PHX-1045/A12

Güç	: 12 W
Çalışma Voltaj	: AC - 110/220V
Işık Akısı	: 2.100 Lümen
Koruma Sınıfı	: IP 65
Montaj Ölçüsü	: 58 x 356 x 58 mm

PHX-1045/A18

Güç	: 18 W
Çalışma Voltaj	: AC - 110/220V
Işık Akısı	: 3.150 Lümen
Koruma Sınıfı	: IP 65
Montaj Ölçüsü	: 52 x 506 x 58 mm

PHX-1045/A24

Güç	: 24 W
Çalışma Voltaj	: AC - 110/220V
Işık Akısı	: 4.200 Lümen
Koruma Sınıfı	: IP 65
Montaj Ölçüsü	: 58 x 756 x 58 mm

PHX-1045/A36

Güç	: 36 W
Çalışma Voltaj	: AC - 110/220V
Işık Akısı	: 6.300 Lümen
Koruma Sınıfı	: IP 65
Montaj Ölçüsü	: 58 x 1006 x 58 mm

PHX-1045/A48

Güç	: 48 W
Çalışma Voltaj	: AC - 110/220V
Işık Akısı	: 8.400 Lümen
Koruma Sınıfı	: IP 65
Montaj Ölçüsü	: 52 x 1306 x 58 mm

Led
NICHIA PHILIPS SAMSUNG
bridgelux OSRAM
SMD Power Led, 175 Lümen/W
50.000 Saat Ömür

**Gövde**

Ekstrüzyon alüminyum gövde, tamperli cam üst kapak

Sürücü

PHILIPS TEX RUN MW MEANWELL PhonexLed

**PHX-1045/3**

Güç	: 3 W
Çalışma Voltaj	: AC - 110/220V
Işık Akısı	: 525 Lümen
Koruma Sınıfı	: IP 65
Montaj Ölçüsü	: 52 x 90 x 58 mm

PHX-1045/6

Güç	: 6 W
Çalışma Voltaj	: AC - 110/220V
Işık Akısı	: 1.050 Lümen
Koruma Sınıfı	: IP 65
Montaj Ölçüsü	: 52 x 170 x 58 mm

PHX-1045/12

Güç	: 12 W
Çalışma Voltaj	: AC - 110/220V
Işık Akısı	: 2.100 Lümen
Koruma Sınıfı	: IP 65
Montaj Ölçüsü	: 52 x 350 x 58 mm

PHX-1045/18

Güç	: 18 W
Çalışma Voltaj	: AC - 110/220V
Işık Akısı	: 3.150 Lümen
Koruma Sınıfı	: IP 65
Montaj Ölçüsü	: 52 x 500 x 58 mm

PHX-1045/24

Güç	: 24 W
Çalışma Voltaj	: AC - 110/220V
Işık Akısı	: 4.200 Lümen
Koruma Sınıfı	: IP 65
Montaj Ölçüsü	: 52 x 750 x 58 mm

PHX-1045/36

Güç	: 36 W
Çalışma Voltaj	: AC - 110/220V
Işık Akısı	: 6.300 Lümen
Koruma Sınıfı	: IP 65
Montaj Ölçüsü	: 52 x 1000 x 58 mm

PHX-1045/48

Güç	: 48 W
Çalışma Voltaj	: AC - 110/220V
Işık Akısı	: 8.400 Lümen
Koruma Sınıfı	: IP 65
Montaj Ölçüsü	: 52 x 1300 x 58 mm

Led
NICHIA PHILIPS SAMSUNG
bridgelux OSRAM
SMD Power Led, 175 Lümen/W
50.000 Saat Ömür

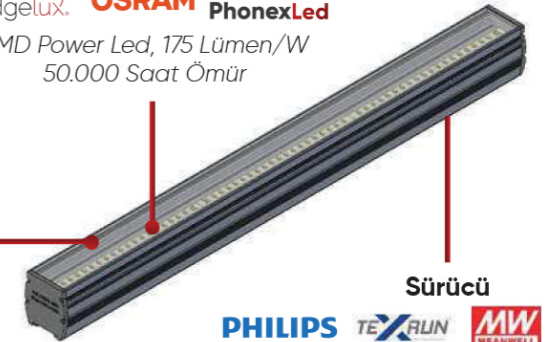
**Gövde**

Ekstrüzyon alüminyum gövde, tamperli cam üst kapak

Sürücü

PHILIPS TEX RUN MW MEANWELL PhonexLed

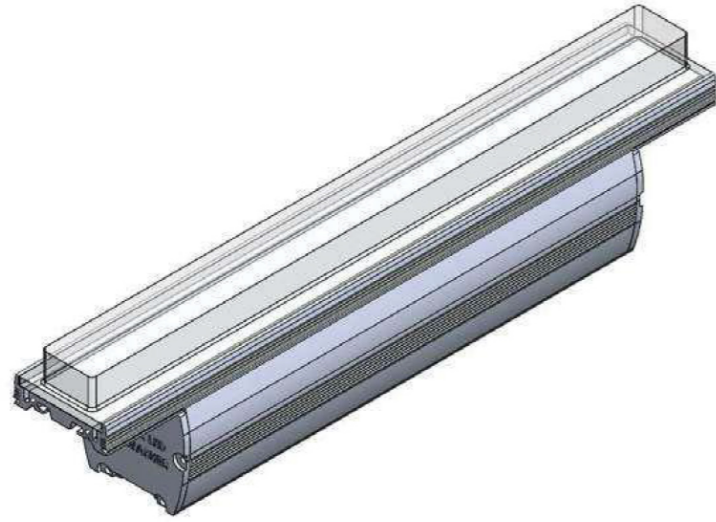

**PHX-1046/3**

Güç	: 3 W
Çalışma Voltaj	: AC - 110/220V
Işık Akısı	: 525 Lümen
Koruma Sınıfı	: IP 65
Montaj Ölçüsü	: 51 x 90 x 71 mm

PHX-1046/6

Güç	: 6 W
Çalışma Voltaj	: AC - 110/220V
Işık Akısı	: 1.050 Lümen
Koruma Sınıfı	: IP 65
Montaj Ölçüsü	: 51 x 170 x 71 mm

PHX-1046/12

Güç	: 12 W
Çalışma Voltaj	: AC - 110/220V
Işık Akısı	: 2.100 Lümen
Koruma Sınıfı	: IP 65
Montaj Ölçüsü	: 51 x 350 x 71 mm

PHX-1046/18

Güç	: 18 W
Çalışma Voltaj	: AC - 110/220V
Işık Akısı	: 3.150 Lümen
Koruma Sınıfı	: IP 65
Montaj Ölçüsü	: 51 x 500 x 71 mm

PHX-1046/24

Güç	: 24 W
Çalışma Voltaj	: AC - 110/220V
Işık Akısı	: 4.200 Lümen
Koruma Sınıfı	: IP 65
Montaj Ölçüsü	: 51 x 750 x 71 mm

PHX-1046/36

Güç	: 36 W
Çalışma Voltaj	: AC - 110/220V
Işık Akısı	: 6.300 Lümen
Koruma Sınıfı	: IP 65
Montaj Ölçüsü	: 51 x 1000 x 71 mm

PHX-1046/48

Güç	: 48 W
Çalışma Voltaj	: AC - 110/220V
Işık Akısı	: 8.400 Lümen
Koruma Sınıfı	: IP 65
Montaj Ölçüsü	: 51 x 1300 x 71 mm

Led
NICHIA PHILIPS SAMSUNG
bridgelux OSRAM PhonexLed
SMD Power Led, 175 Lümen/W
50.000 Saat Ömür



Gövde

Ekstrüzyon alüminyum gövde, polikarbon üst kapak

Sürücü

PHILIPS TEZ RUN MW MEANWELL PhonexLed

PHX-1010

Güç	: 60 W
Çalışma Voltaj	: AC - 110/220V
Işık Akısı	: 10.500 Lümen
Koruma Sınıfı	: IP 65
Montaj Ölçüsü	: 320 x 320 x 150 mm
Ürün Ölçüsü	: 405 x 405 mm 605 x 605 mm

PHX-1010

Güç	: 120 W
Çalışma Voltaj	: AC - 110/220V
Işık Akısı	: 21.000 Lümen
Koruma Sınıfı	: IP 65
Montaj Ölçüsü	: 320 x 320 x 150 mm
Ürün Ölçüsü	: 405 x 405 mm 605 x 605 mm

PHX-1010

Güç	: 150 W
Çalışma Voltaj	: AC - 110/220V
Işık Akısı	: 26.250 Lümen
Koruma Sınıfı	: IP 65
Montaj Ölçüsü	: 320 x 320 x 150 mm
Ürün Ölçüsü	: 405 x 405 mm 605 x 605 mm

Sürücü
PHILIPS TEZ RUN MW MEANWELL PhonexLed

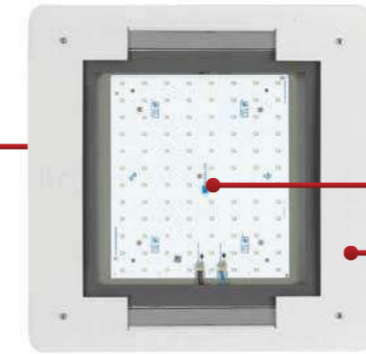

Led
NICHIA PHILIPS SAMSUNG
bridgelux OSRAM PhonexLed
SMD Power Led, 175 Lümen/W
50.000 Saat Ömür

Gövde

Enjeksiyon alüminyum elektrostatik boyalı gövde,
4mm tamperli cam ve hareketli montaj ayağı



**PHX-1016**

Güç	: 60 W
Çalışma Voltaj	: AC - 110/220V
Işık Akısı	: 10.500 Lümen
Koruma Sınıfı	: IP 20
Montaj Ölçüsü	: 370 Ø x 160 mm

PHX-1017

Güç	: 120 W
Çalışma Voltaj	: AC - 110/220V
Işık Akısı	: 21.000 Lümen
Koruma Sınıfı	: IP 20
Montaj Ölçüsü	: 370 Ø x 160 mm

PHX-1018

Güç	: 150 W
Çalışma Voltaj	: AC - 110/220V
Işık Akısı	: 26.500 Lümen
Koruma Sınıfı	: IP 20
Montaj Ölçüsü	: 370 Ø x 160 mm

**PHX-1030-M/100**

Güç	: 100 W
Çalışma Voltaj	: AC - 110/220V
Işık Akısı	: 17.500 Lümen
Koruma Sınıfı	: IP 20
Montaj Ölçüsü	: 120 x 1000 x 70 mm

PHX-1030-M/150

Güç	: 150 W
Çalışma Voltaj	: AC - 110/220V
Işık Akısı	: 26.250 Lümen
Koruma Sınıfı	: IP 20
Montaj Ölçüsü	: 120 x 1000 x 70 mm

PHX-1030-M/180

Güç	: 180 W
Çalışma Voltaj	: AC - 110/220V
Işık Akısı	: 31.500 Lümen
Koruma Sınıfı	: IP 20
Montaj Ölçüsü	: 120 x 1000 x 70 mm

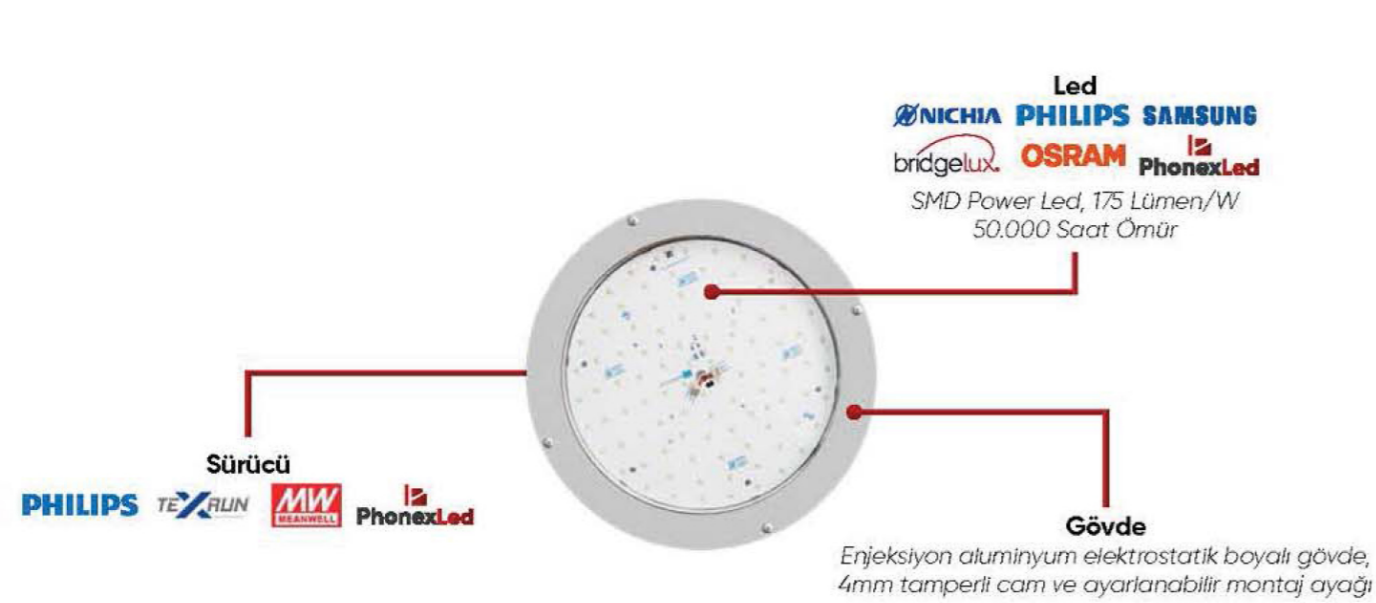

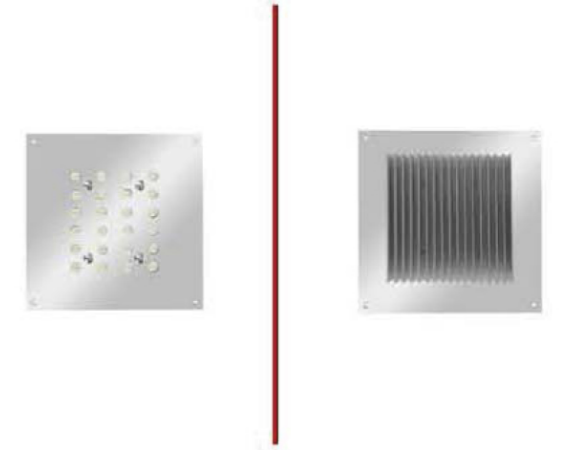
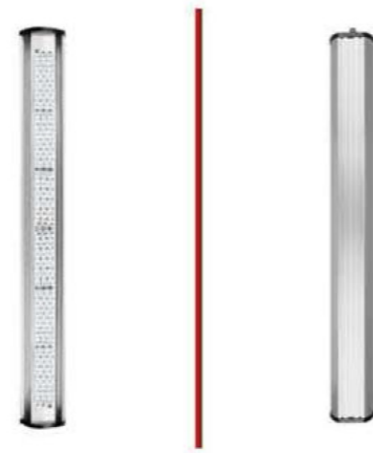
**PHX-1030 / 60**

Güç	: 60 W
Çalışma Voltaj	: AC - 110/220V
Işık Akısı	: 10.500 Lümen
Koruma Sınıfı	: IP 20
Montaj Ölçüsü	: 120 x 1000 x 70 mm

PHX-1030 / 120

Güç	: 120 W
Çalışma Voltaj	: AC - 110/220V
Işık Akısı	: 21.000 Lümen
Koruma Sınıfı	: IP 20
Montaj Ölçüsü	: 120 x 1000 x 70 mm

PHX-1030 / 150

Güç	: 150 W
Çalışma Voltaj	: AC - 110/220V
Işık Akısı	: 26.250 Lümen
Koruma Sınıfı	: IP 20
Montaj Ölçüsü	: 120 x 1000 x 70 mm

PHX-1041

Güç	: 40 W
Çalışma Voltaj	: AC - 110/220V
Işık Akısı	: 7000 Lümen
Koruma Sınıfı	: IP 20
Montaj Ölçüsü	: 170 x 170 x 50 mm

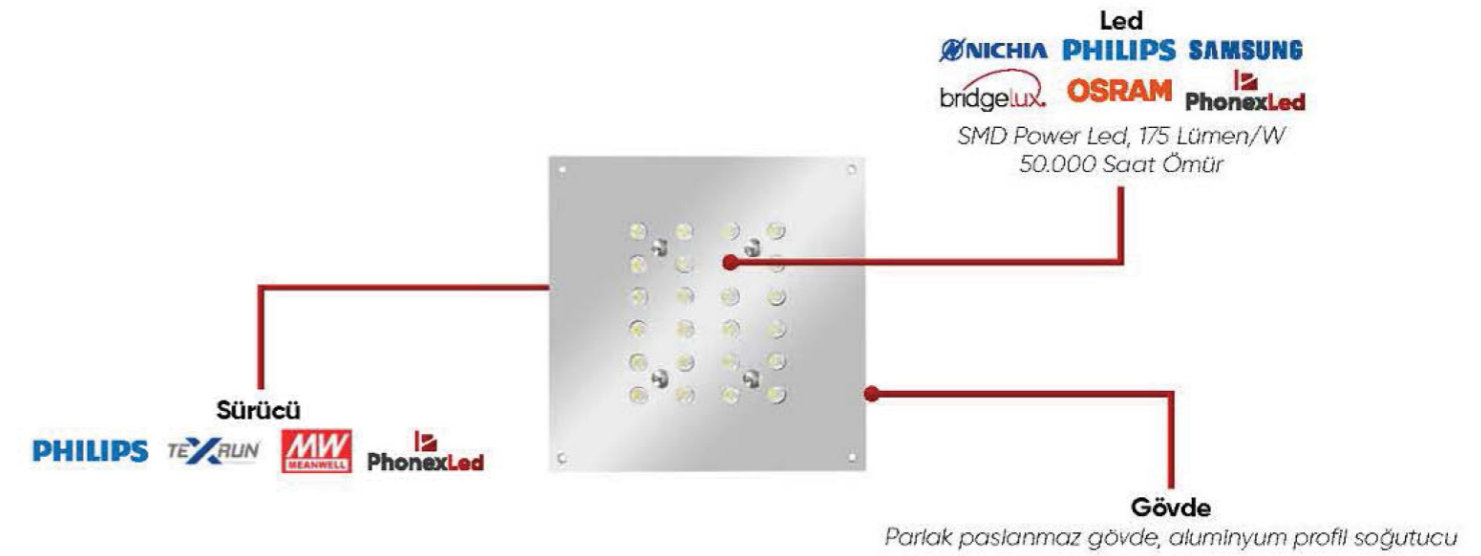

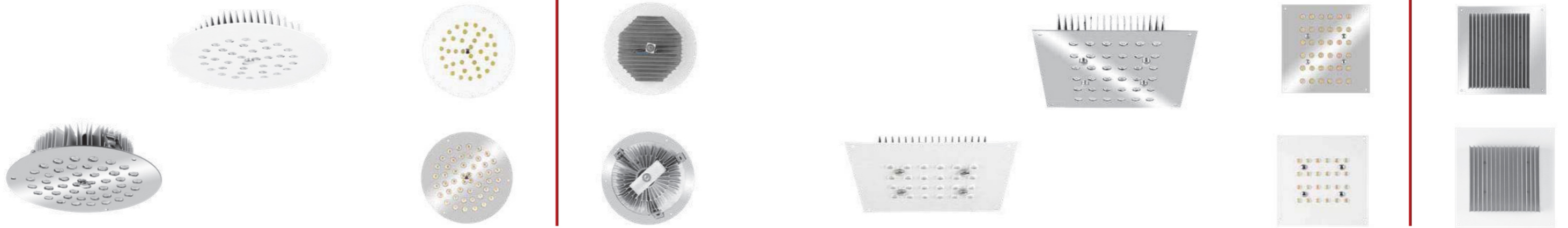
**PHX-1042**

Güç	: 40 W
Çalışma Voltaj	: AC - 110/220V
Işık Akısı	: 7000 Lümen
Koruma Sınıfı	: IP 20
Delik Çapı	: 160 mm
Dış Çapı	: 240 mm

PHX-1043

Güç	: 60 W
Çalışma Voltaj	: AC - 110/220V
Işık Akısı	: 10.500 Lümen
Koruma Sınıfı	: IP 20
Delik Çapı	: 160 mm
Dış Çapı	: 240 mm

PHX-1044

Güç	: 40 W
Çalışma Voltaj	: AC - 110/220V
Işık Akısı	: 7000 Lümen
Koruma Sınıfı	: IP 20
Delik Ölçü	: 160 x 160 mm
Dış Ölçü	: 240 x 260 mm

PHX-1045

Güç	: 60 W
Çalışma Voltaj	: AC - 110/220V
Işık Akısı	: 10.500 Lümen
Koruma Sınıfı	: IP 20
Delik Ölçü	: 160 x 160 mm
Dış Ölçü	: 240 x 260 mm

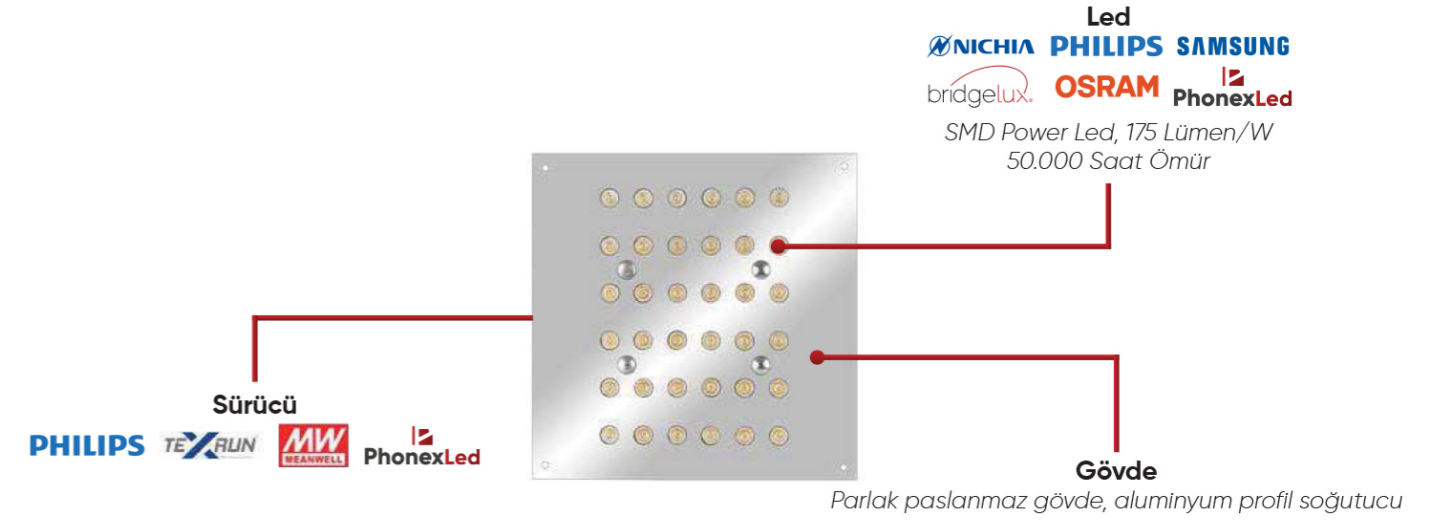
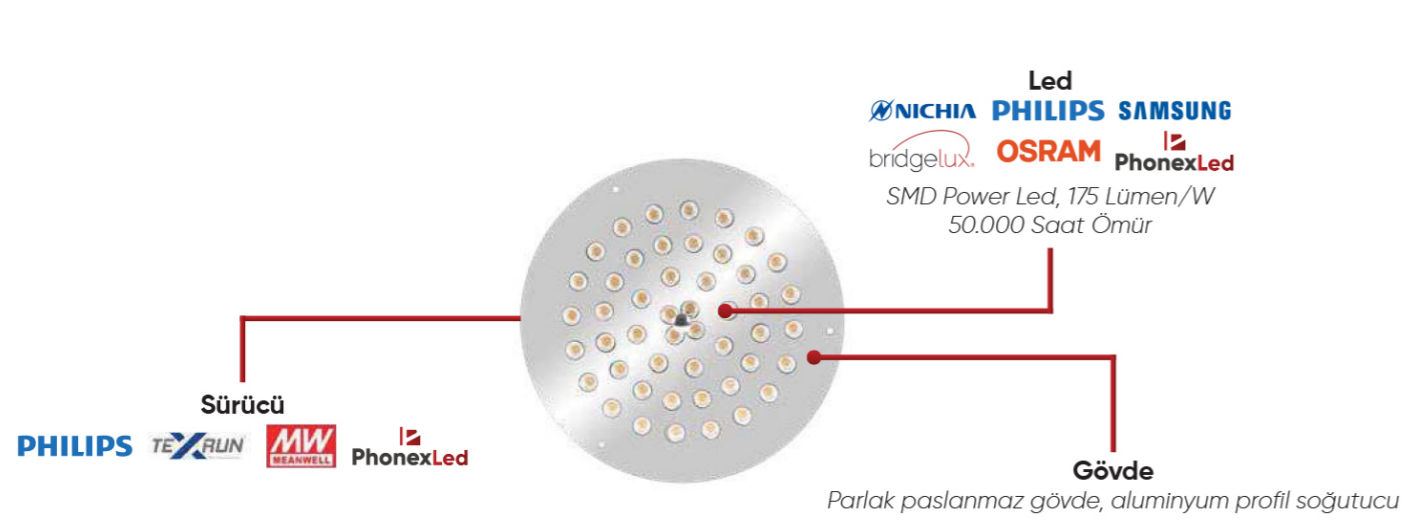



PHX-1046

Güç	: 20 W
Çalışma Voltaj	: AC - 110/220V
Işık Akısı	: 3.500 Lümen
Koruma Sınıfı	: IP 20
Delik Ölçü	: 300 x 45 mm
Dış Ölçü	: 340 x 55 mm

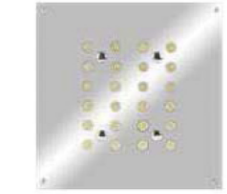

PHX-1047

Güç	: 20 W
Çalışma Voltaj	: AC - 110/220V
Işık Akısı	: 3.500 Lümen
Koruma Sınıfı	: IP 20
Delik Ölçüsü	: 80 x 100 mm
Dış Ölçüsü	: 150 x 100 mm

PHX-1048

Güç	: 40 W
Çalışma Voltaj	: AC - 110/220V
Işık Akısı	: 7000 Lümen
Koruma Sınıfı	: IP 20
Dış Ölçüsü	: 250 x 250 mm

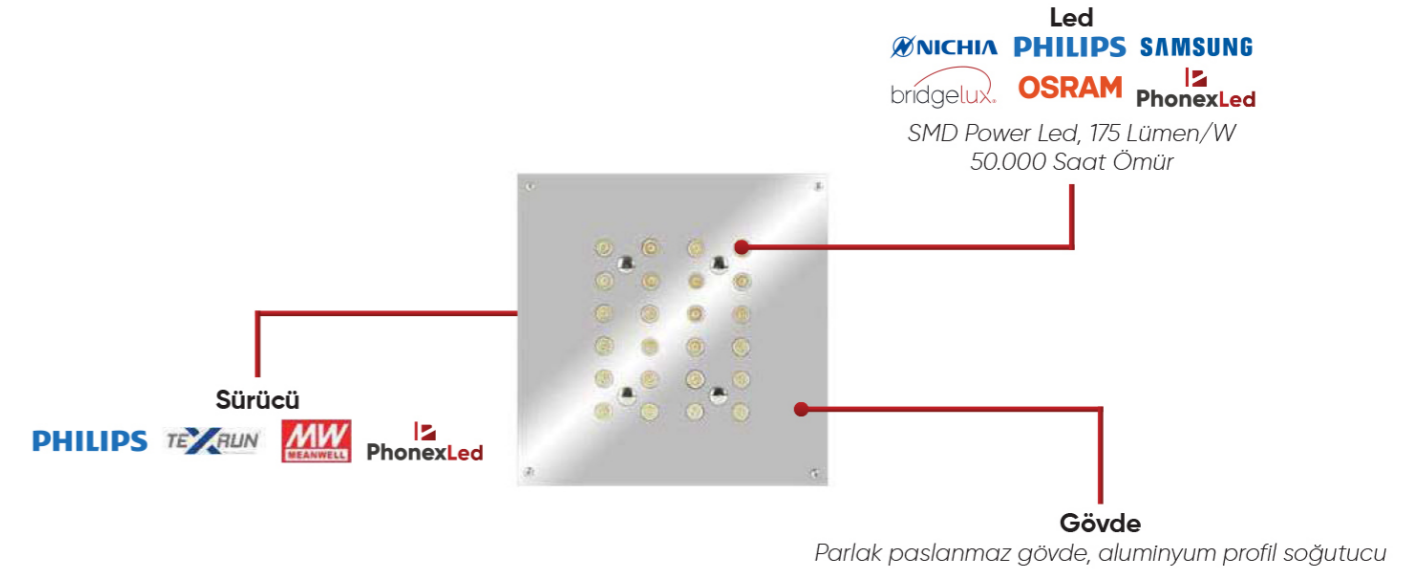
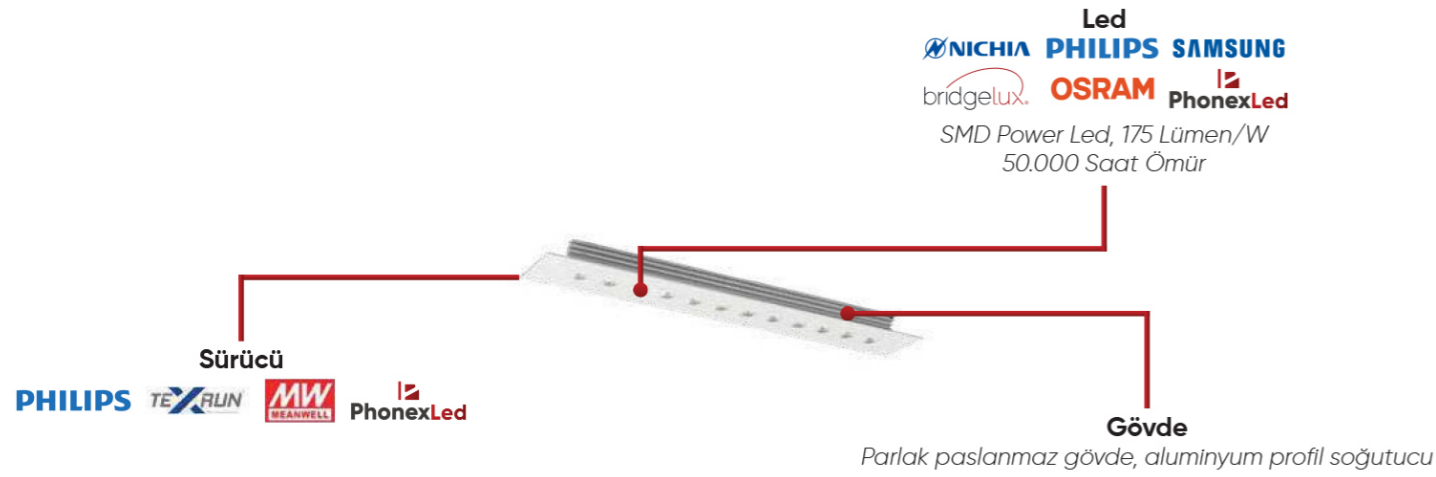

**PHX-1049**

Güç	: 30 W
Çalışma Voltaj	: DC - 12V
Işık Akısı	: 4.500 Lümen
Koruma Sınıfı	: IP 67
Montaj Ölçüsü	: Par 56 Ampul

**PHX-1051**

Güç	: 30 W
Çalışma Voltaj	: DC - 12V
Işık Akısı	: 4.500 Lümen
Koruma Sınıfı	: IP 67
Montaj Ölçüsü	: Sıva Üstü



**PHX-1055 (30W)**

Güç	: 30 W
Çalışma Voltaj	: AC - 110/220V
Işık Akısı	: 4.500 Lümen
Koruma Sınıfı	: IP 20
Montaj Ölçüsü	: 170 x 170 x 100 mm

PHX-1055 (40W)

Güç	: 40 W
Çalışma Voltaj	: AC - 110/220V
Işık Akısı	: 6.000 Lümen
Koruma Sınıfı	: IP 20
Montaj Ölçüsü	: 170 x 170 x 100 mm

PHX-1055 (50W)

Güç	: 50 W
Çalışma Voltaj	: AC - 110/220V
Işık Akısı	: 7.500 Lümen
Koruma Sınıfı	: IP 20
Montaj Ölçüsü	: 170 x 170 x 100 mm

**PHX-1056 (30W)**

Güç	: 30 W
Çalışma Voltaj	: AC - 110/220V
Işık Akısı	: 4.500 Lümen
Koruma Sınıfı	: IP 20
Montaj Ölçüsü	: 100 x 200 x 160 mm

PHX-1056 (40W)

Güç	: 40 W
Çalışma Voltaj	: AC - 110/220V
Işık Akısı	: 6.000 Lümen
Koruma Sınıfı	: IP 20
Montaj Ölçüsü	: 100 x 200 x 160 mm

PHX-1056 (50W)

Güç	: 50 W
Çalışma Voltaj	: AC - 110/220V
Işık Akısı	: 7.500 Lümen
Koruma Sınıfı	: IP 20
Montaj Ölçüsü	: 100 x 200 x 160 mm

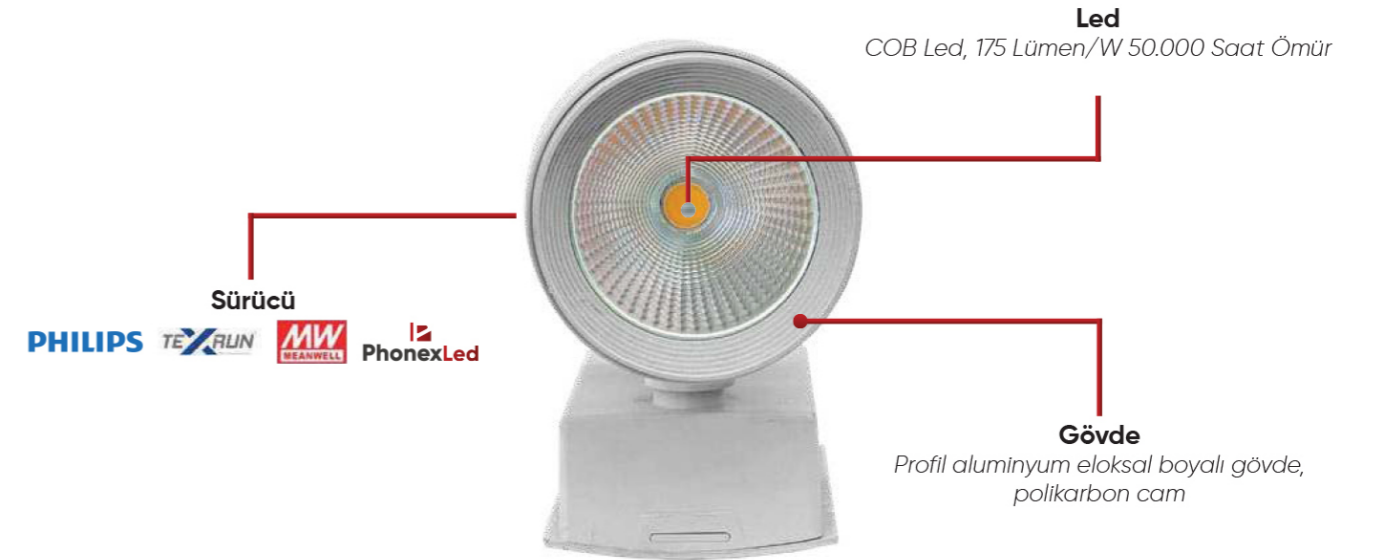



PHX-1052 (40W)

Güç	: 40 W
Çalışma Voltaj	: AC - 110/220V
Işık Akısı	: 7000 Lümen
Koruma Sınıfı	: IP 20
Montaj Ölçüsü	: 30 x 1000 x 16 mm

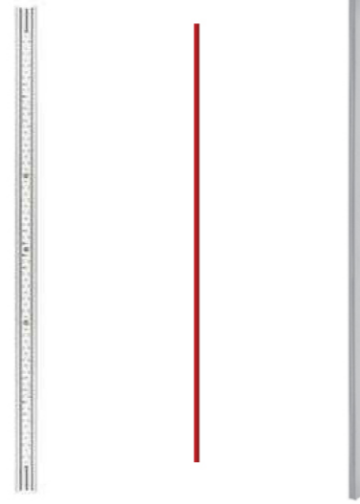

PHX-1052 (60W)

Güç	: 60 W
Çalışma Voltaj	: AC - 110/220V
Işık Akısı	: 10.500 Lümen
Koruma Sınıfı	: IP 65
Montaj Ölçüsü	: 30 x 1000 x 16 mm



PHX-2514

Güç	: 92 W / metre
Çalışma Voltaj	: AC - 110/220V
Işık Akısı	: 750 Lümen
Koruma Sınıfı	: IP 67
Montaj Ölçüsü	: 1000 x 8 x 16 mm

Gövde
Profil alüminyum eloksallı boyalı gövde,
polikarbon cam, hareketli montaj ayağı

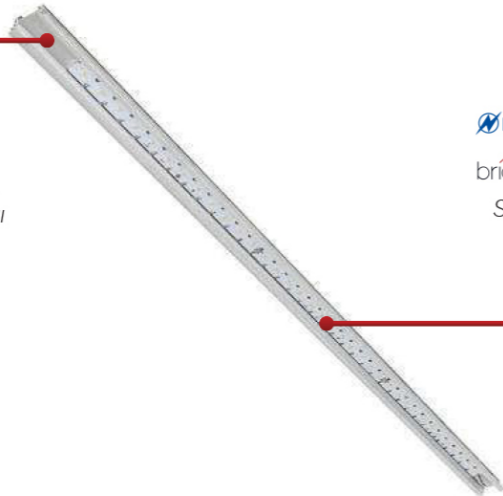

Led
NICHIA PHILIPS SAMSUNG
bridgelux OSRAM PhonexLed
SMD Power Led, 175 Lümen/W
50.000 Saat Ömür

Sürücü
PHILIPS TEX RUN MW MEANWELL PhonexLed



Uzun Ömürlü Enerji Tasarrufu Çevre Dostu Kolay Montaj IP20 Yapı Bütünlüğü IP65 Yapı Bütünlüğü Topraklama Kalite Belgesi ENEC Sertifika ATEX Sertifika RoHS Sertifika Kasa Rengi Değişebilir

Led
SMD Led, 80 Lümen/W, 50.000 Saat Ömür

Gövde
Bükülebilir polikarbon gövde

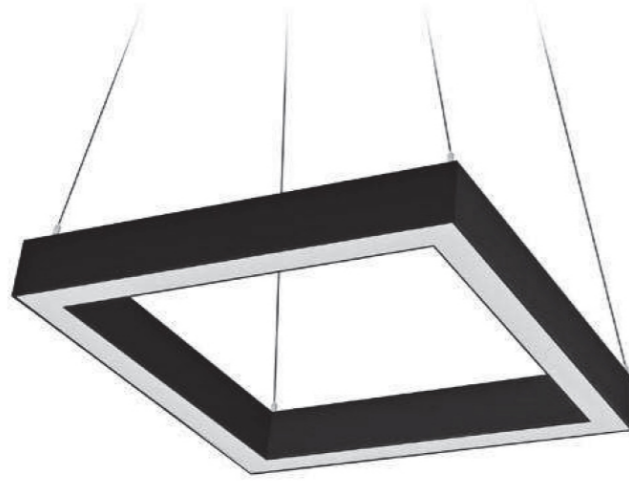

Uzun Ömürlü Enerji Tasarrufu Çevre Dostu Kolay Montaj IP67 Yapı Bütünlüğü Topraklama Kalite Belgesi ENEC Sertifika ATEX Sertifika RoHS Sertifika Kasa Rengi Değişebilir

**PHX-1610**

Güç	: 40 W
Çalışma Voltaj	: AC - 110/220V
Işık Akısı	: 7000 Lümen
Koruma Sınıfı	: IP 20
Montaj Ölçüsü	: 500 x 100 x 55 mm

PHX-1611

Güç	: 80 W
Çalışma Voltaj	: AC - 110/220V
Işık Akısı	: 14.000 Lümen
Koruma Sınıfı	: IP 20
Montaj Ölçüsü	: 1000 x 1000 x 55 mm

PHX-1612

Güç	: 120 W
Çalışma Voltaj	: AC - 110/220V
Işık Akısı	: 26.100 Lümen
Koruma Sınıfı	: IP 20
Montaj Ölçüsü	: 1500 x 1500 x 55 mm

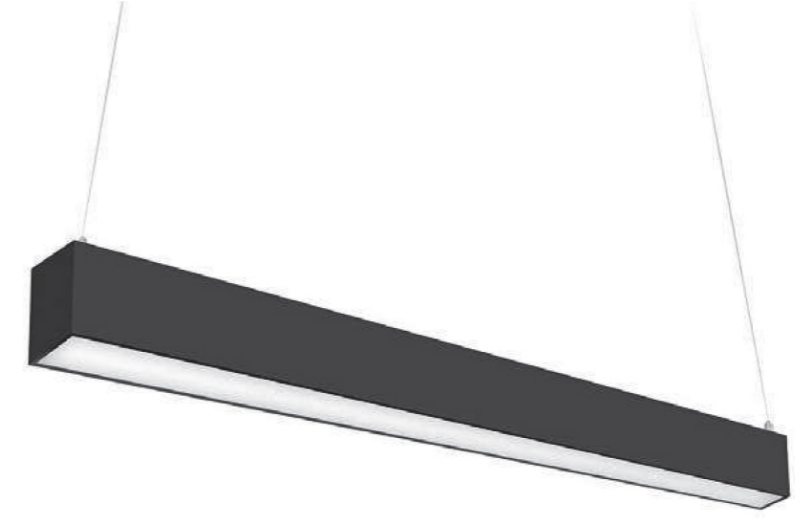
**PHX-1620**

Güç	: 60 W
Çalışma Voltaj	: AC - 110/220V
Işık Akısı	: 10.500 Lümen
Koruma Sınıfı	: IP 20
Montaj Ölçüsü	: 1000 x 65 x 55 mm

PHX-1621

Güç	: 120 W
Çalışma Voltaj	: AC - 110/220V
Işık Akısı	: 21.000 Lümen
Koruma Sınıfı	: IP 20
Montaj Ölçüsü	: 2000 x 65 x 55 mm

PHX-1622

Güç	: 120 W
Çalışma Voltaj	: AC - 110/220V
Işık Akısı	: 31.500 Lümen
Koruma Sınıfı	: IP 20
Montaj Ölçüsü	: 3000 x 65 x 55 mm

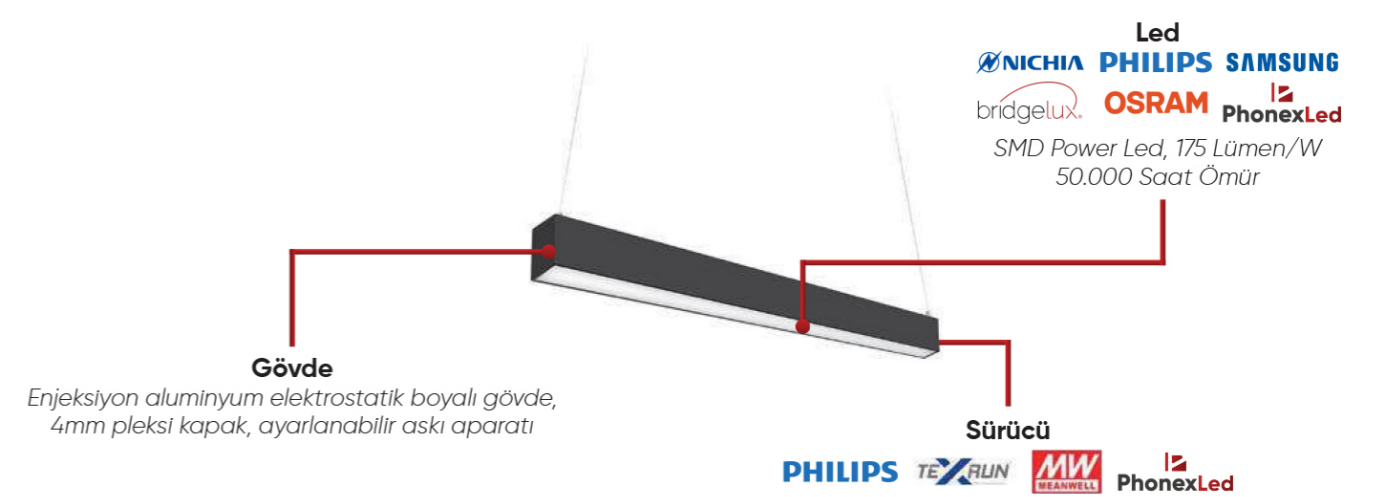
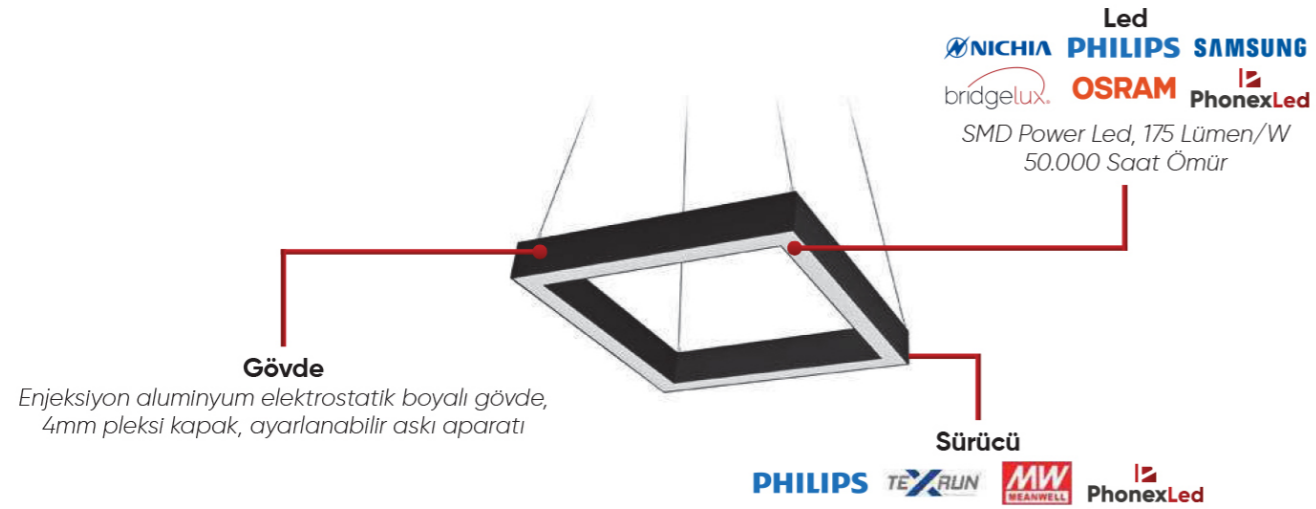

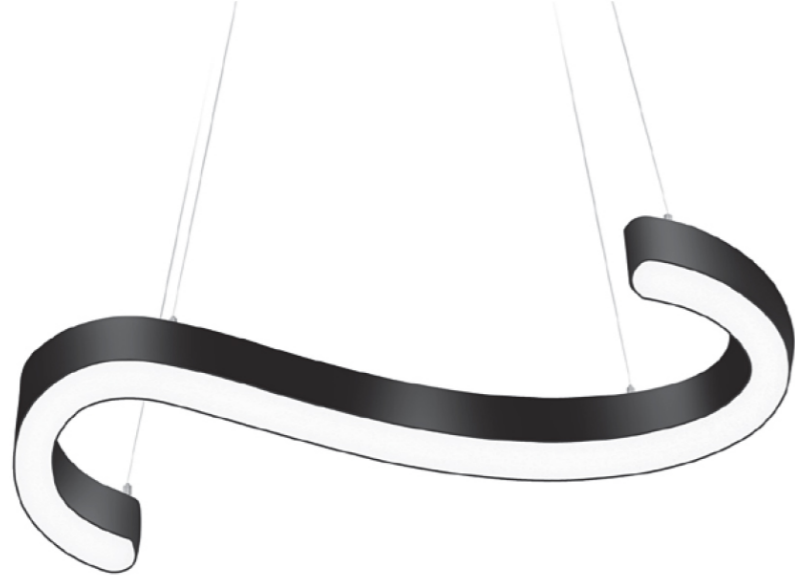
**PHX-1630**

Güç	: 60 W
Çalışma Voltaj	: AC - 110/220V
Işık Akısı	: 7000 Lümen
Koruma Sınıfı	: IP 20
Montaj Ölçüsü	: 1000 mm

PHX-1631

Güç	: 80 W
Çalışma Voltaj	: AC - 110/220V
Işık Akısı	: 11.600 Lümen
Koruma Sınıfı	: IP 20
Montaj Ölçüsü	: 1200 mm

PHX-1632

Güç	: 100 W
Çalışma Voltaj	: AC - 110/220V
Işık Akısı	: 14.500 Lümen
Koruma Sınıfı	: IP 20
Montaj Ölçüsü	: 1500 mm

**PHX-1640**

Güç	: 40 W
Çalışma Voltaj	: AC - 110/220V
Işık Akısı	: 5.800 Lümen
Koruma Sınıfı	: IP 20
Montaj Ölçüsü	: 600 x 145 x 55 mm

PHX-1641

Güç	: 60 W
Çalışma Voltaj	: AC - 110/220V
Işık Akısı	: 8.700 Lümen
Koruma Sınıfı	: IP 20
Montaj Ölçüsü	: 1000 x 145 x 55 mm

PHX-1642

Güç	: 100 W
Çalışma Voltaj	: AC - 110/220V
Işık Akısı	: 17.400 Lümen
Koruma Sınıfı	: IP 20
Montaj Ölçüsü	: 1200 x 145 x 55 mm

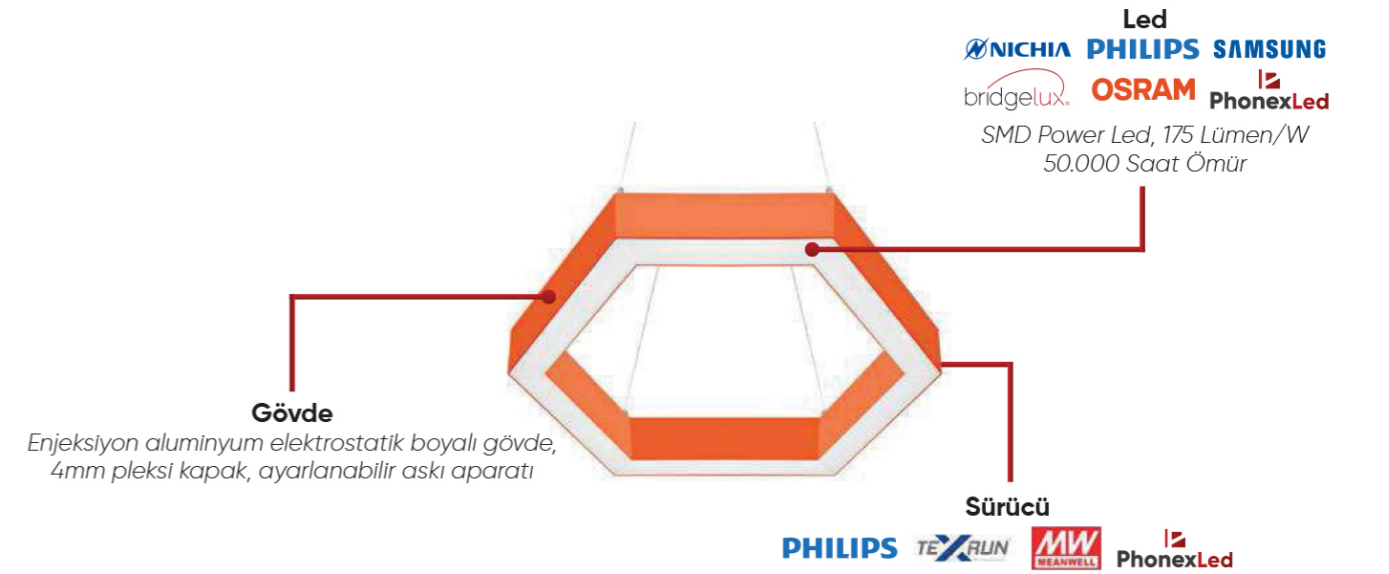
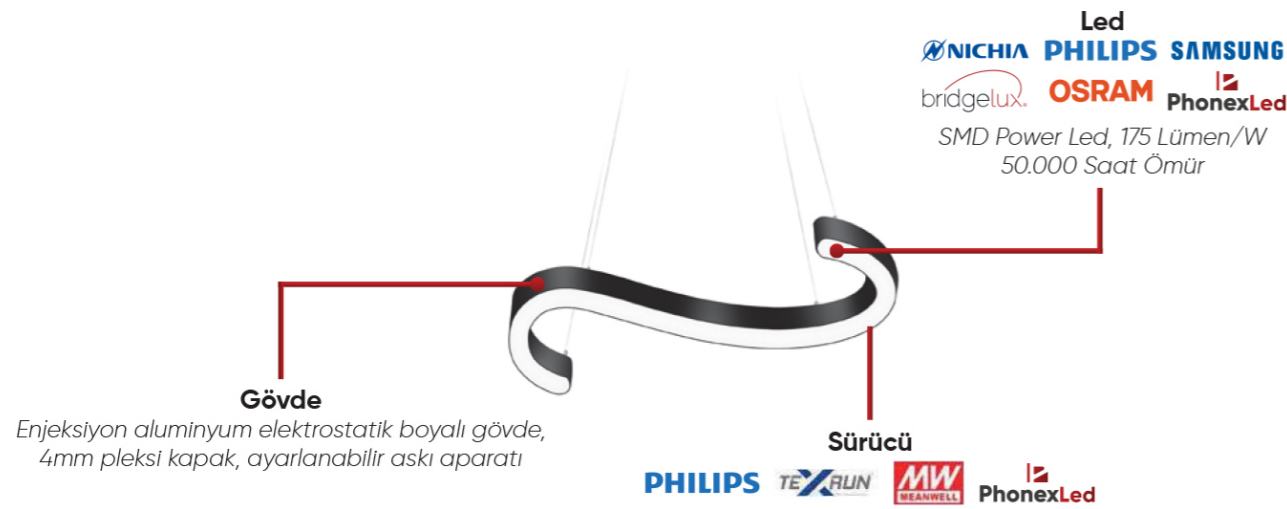

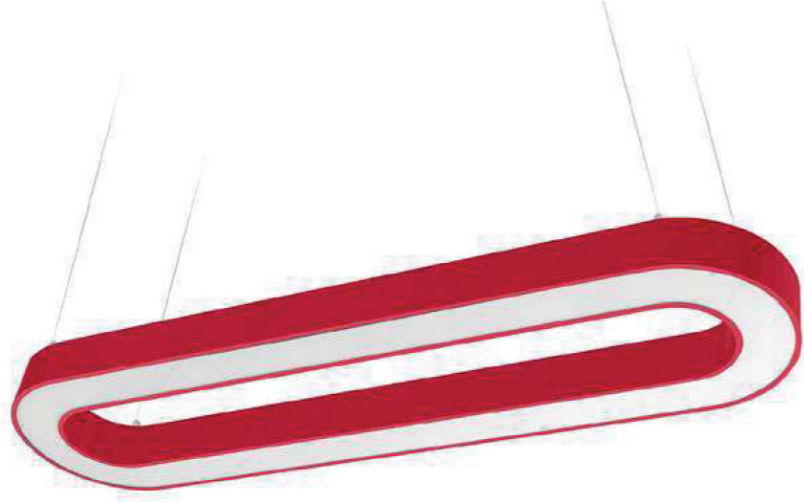
**PHX-1650**

Güç	: 40 W
Çalışma Voltaj	: AC - 110/220V
Işık Akısı	: 8.700 Lümen
Koruma Sınıfı	: IP 20
Montaj Ölçüsü	: 1000 mm

PHX-1651

Güç	: 80 W
Çalışma Voltaj	: AC - 110/220V
Işık Akısı	: 11.600 Lümen
Koruma Sınıfı	: IP 20
Montaj Ölçüsü	: 1200 mm

PHX-1652

Güç	: 120 W
Çalışma Voltaj	: AC - 110/220V
Işık Akısı	: 14.500 Lümen
Koruma Sınıfı	: IP 20
Montaj Ölçüsü	: 1500 mm

**PHX-1660**

Güç	: 40 W
Çalışma Voltaj	: AC - 110/220V
Işık Akısı	: 8.700 Lümen
Koruma Sınıfı	: IP 20
Montaj Ölçüsü	: 600 x 65 x 55 mm

PHX-1661

Güç	: 80 W
Çalışma Voltaj	: AC - 110/220V
Işık Akısı	: 11.600 Lümen
Koruma Sınıfı	: IP 20
Montaj Ölçüsü	: 800 x 65 x 55 mm

PHX-1662

Güç	: 120 W
Çalışma Voltaj	: AC - 110/220V
Işık Akısı	: 14.500 Lümen
Koruma Sınıfı	: IP 20
Montaj Ölçüsü	: 1000 x 65 x 55 mm

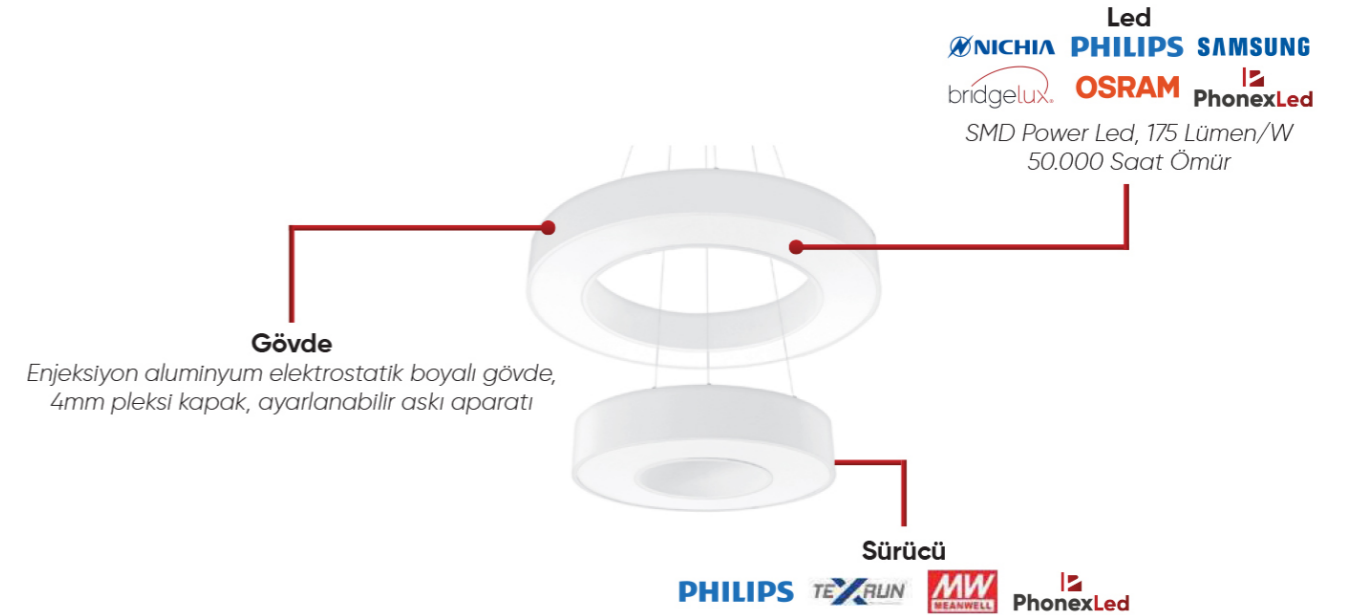
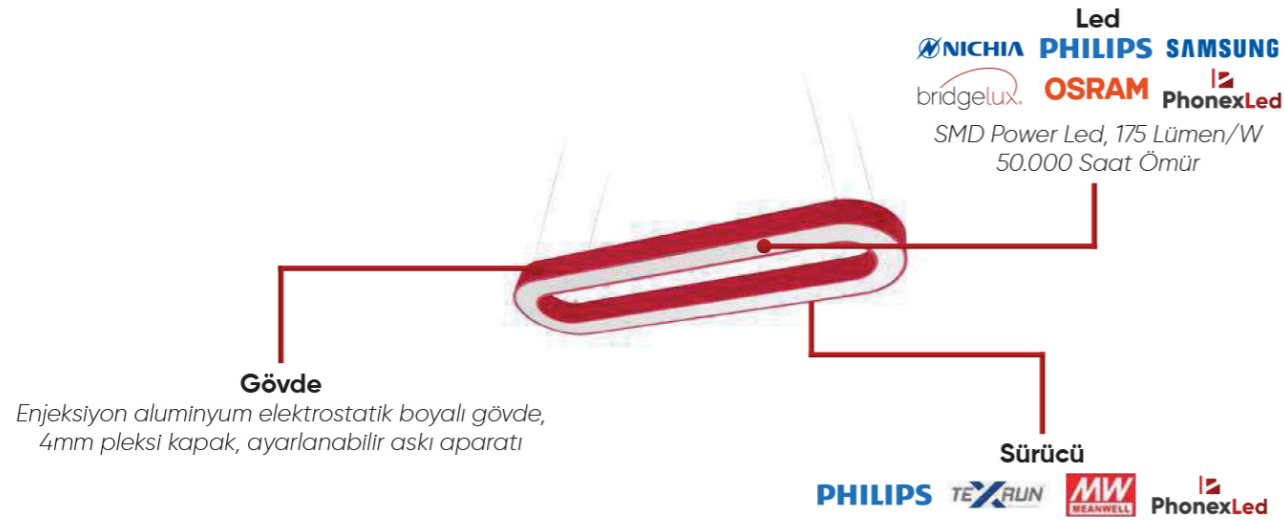

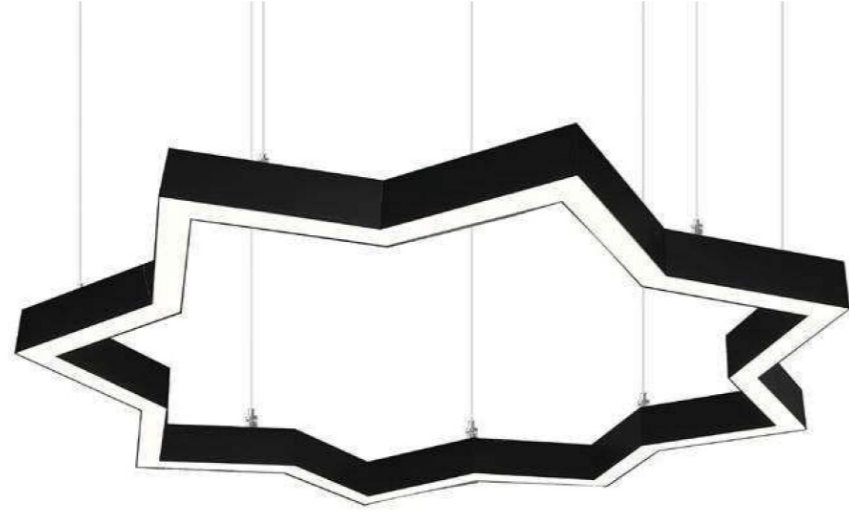

PHX-1670

Güç	: 120 W
Çalışma Voltaj	: AC - 110/220V
Işık Akısı	: 21.000 Lümen
Koruma Sınıfı	: IP 20
Montaj Ölçüsü	: 140 x 140 cm



PHX-1680

Güç	: 60 W
Çalışma Voltaj	: AC - 110/220V
Işık Akısı	: 10.500 Lümen
Koruma Sınıfı	: IP 20
Montaj Ölçüsü	: 60 cm

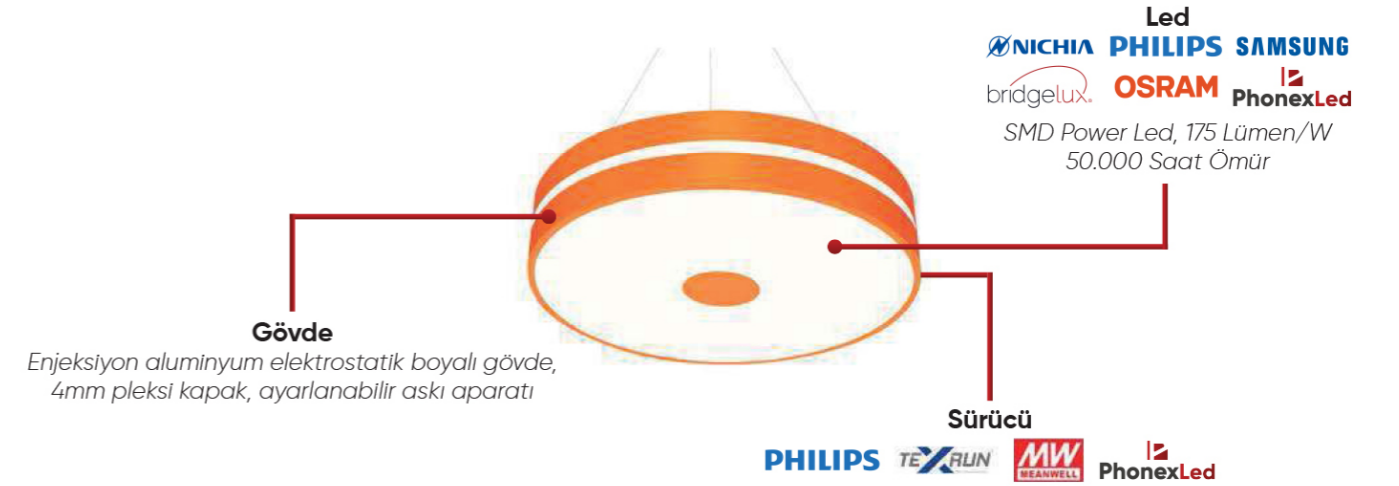
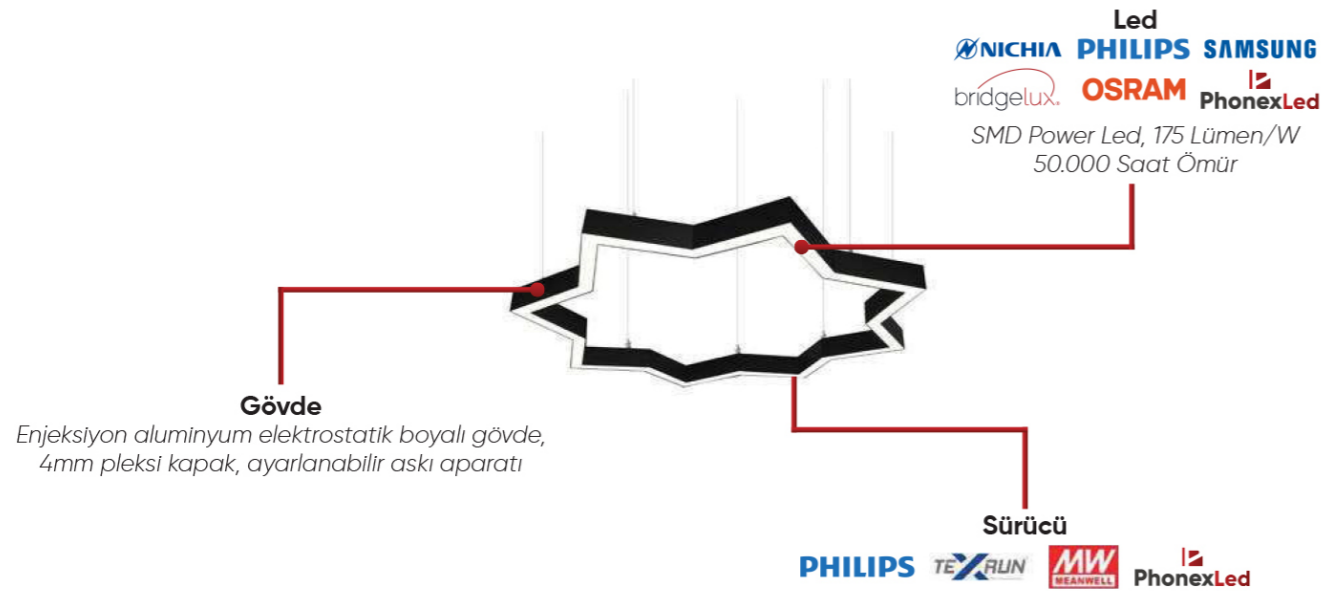



PHX-1690

Güç	: 50 W
Çalışma Voltaj	: AC - 110/220V
Işık Akısı	: 8.750 Lümen
Koruma Sınıfı	: IP 20
Montaj Ölçüsü	: 90 cm

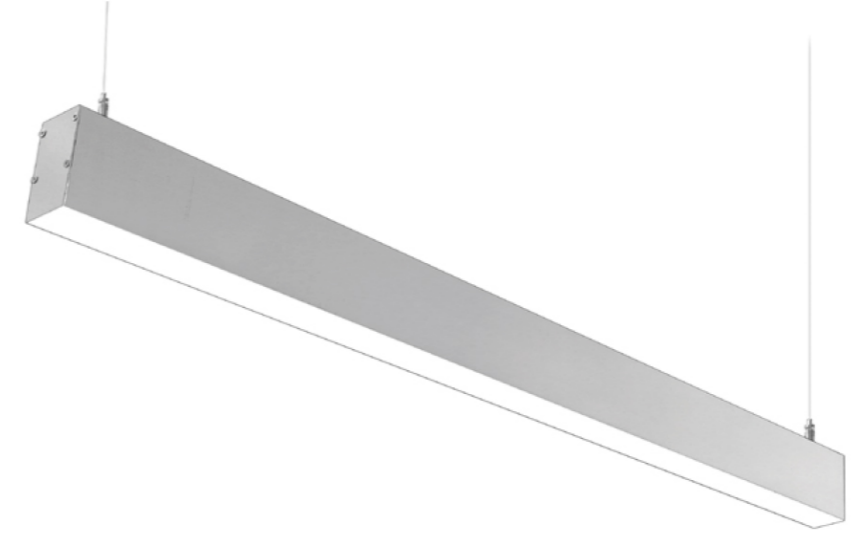
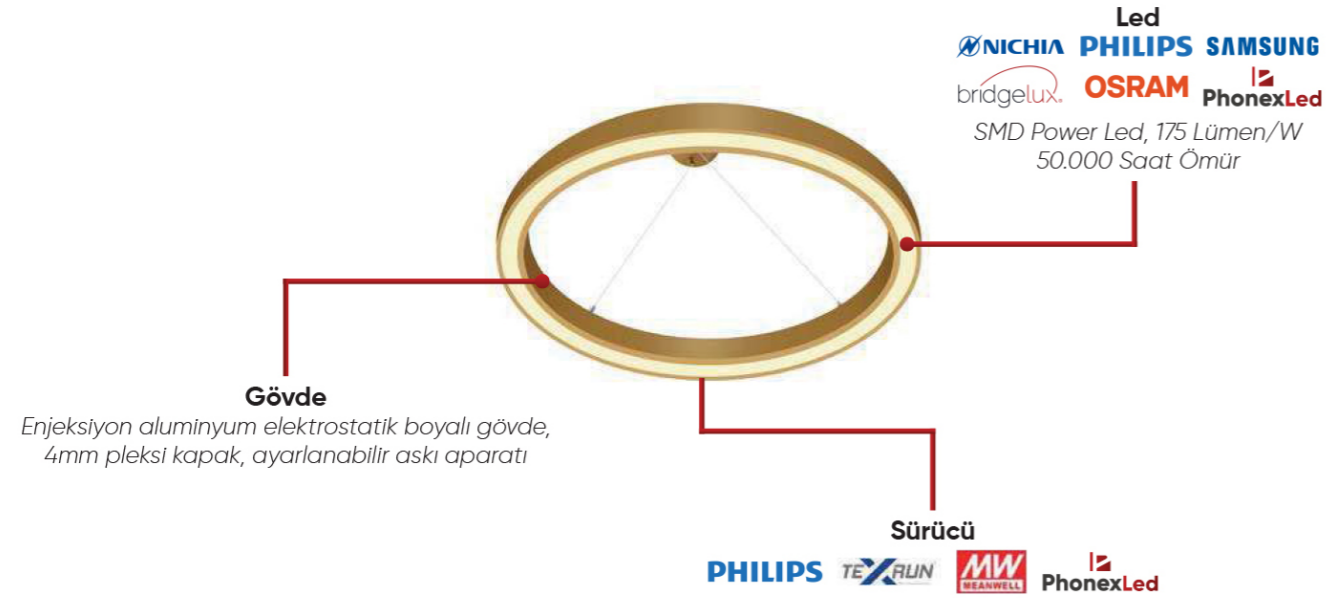

PHX-1700

Güç	: 40 W
Çalışma Voltaj	: AC - 110/220V
Işık Akısı	: 7000 Lümen
Koruma Sınıfı	: IP 20
Montaj Ölçüsü	: 50 x 1000 x 80 mm

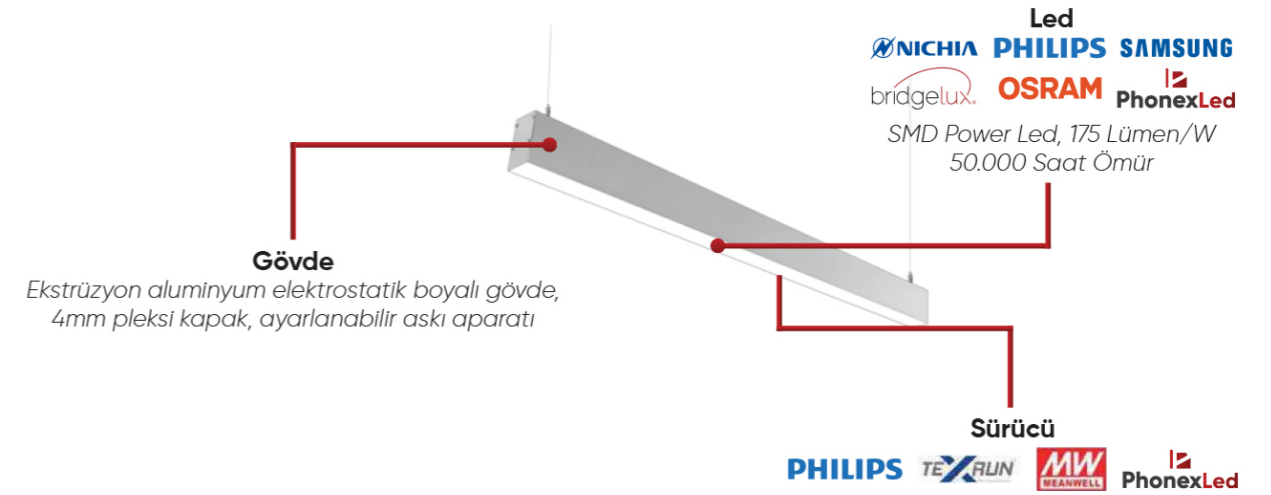

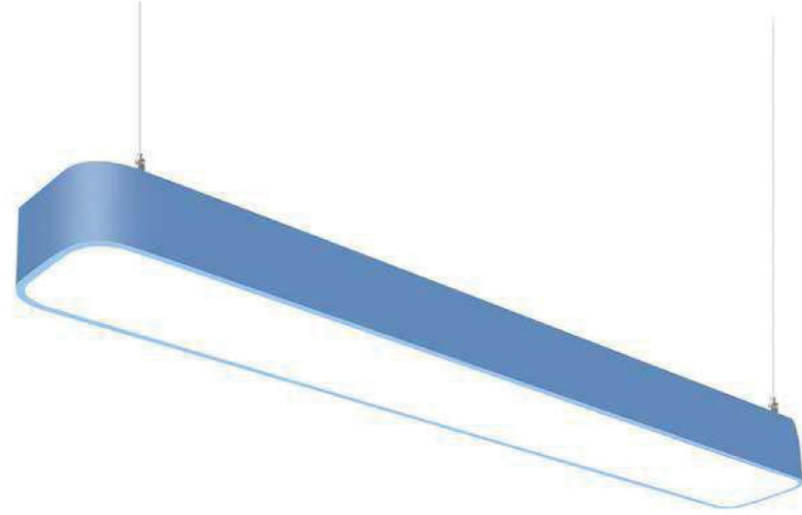

PHX-1710

Güç	: 60 W
Çalışma Voltaj	: AC - 110/220V
Işık Akısı	: 10.500 Lümen
Koruma Sınıfı	: IP 20
Montaj Ölçüsü	: 150 x 1000 x 70 mm

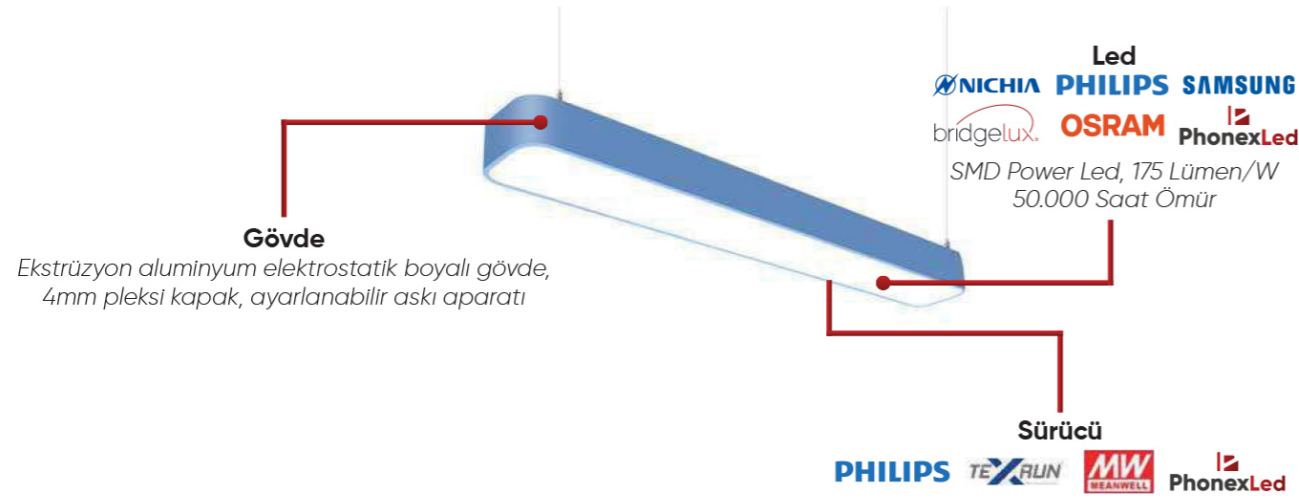

PHX-1720

Güç	: 80 W
Çalışma Voltaj	: AC - 110/220V
Işık Akısı	: 14.000 Lümen
Koruma Sınıfı	: IP 20
Montaj Ölçüsü	: 35 x 35 x 1000 mm

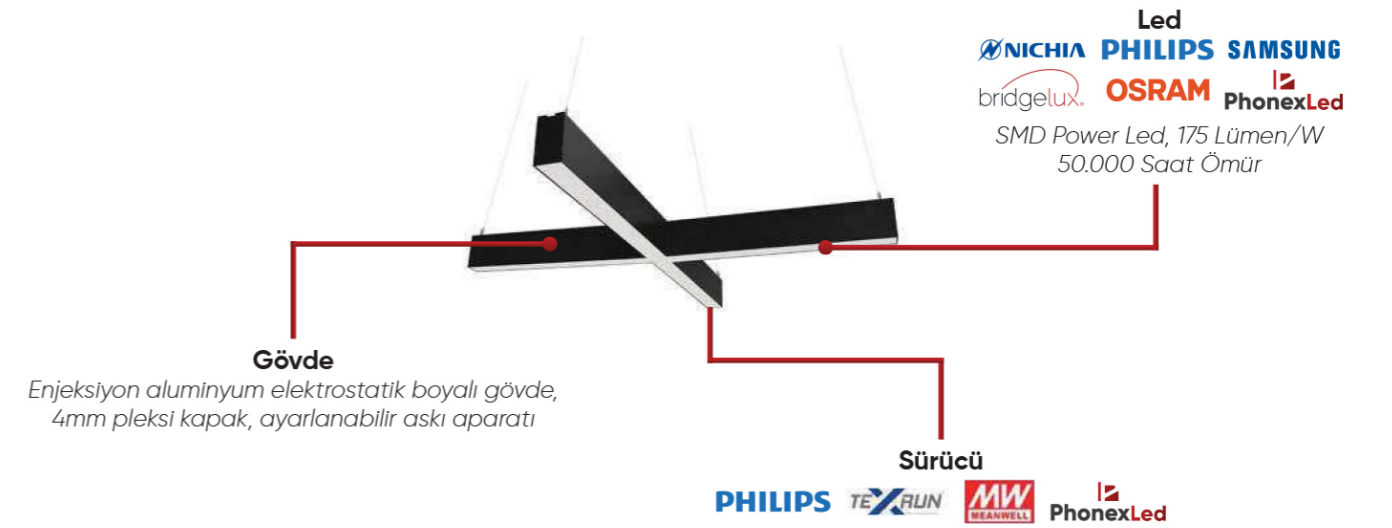

**PHX-1730**

Güç	: 40 W
Çalışma Voltaj	: AC - 110/220V
Işık Akısı	: 7.000 Lümen
Koruma Sınıfı	: IP 20
Montaj Ölçüsü	: 590 x 1030 x 70 mm

**PHX-1050/B**

Güç	: 50 W
Çalışma Voltaj	: AC - 110/220V
Işık Akısı	: 8.750 Lümen
Koruma Sınıfı	: IP 65
Montaj Ölçüsü	: 210 x 110 x 100 mm

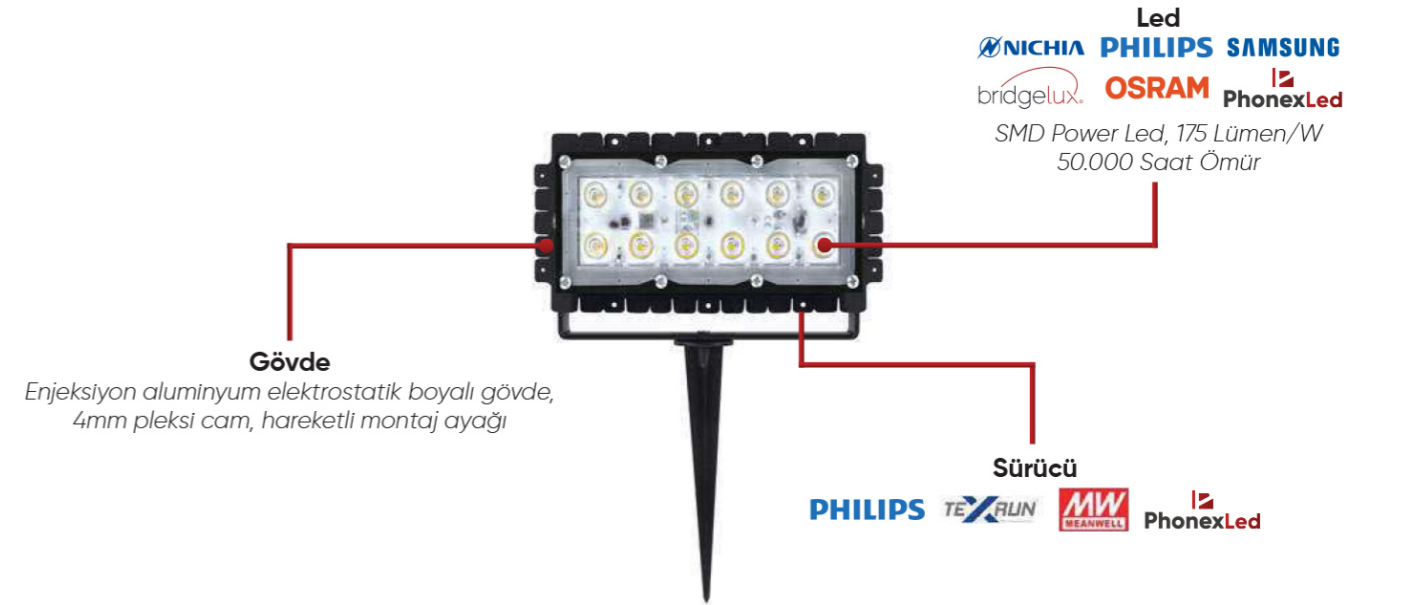
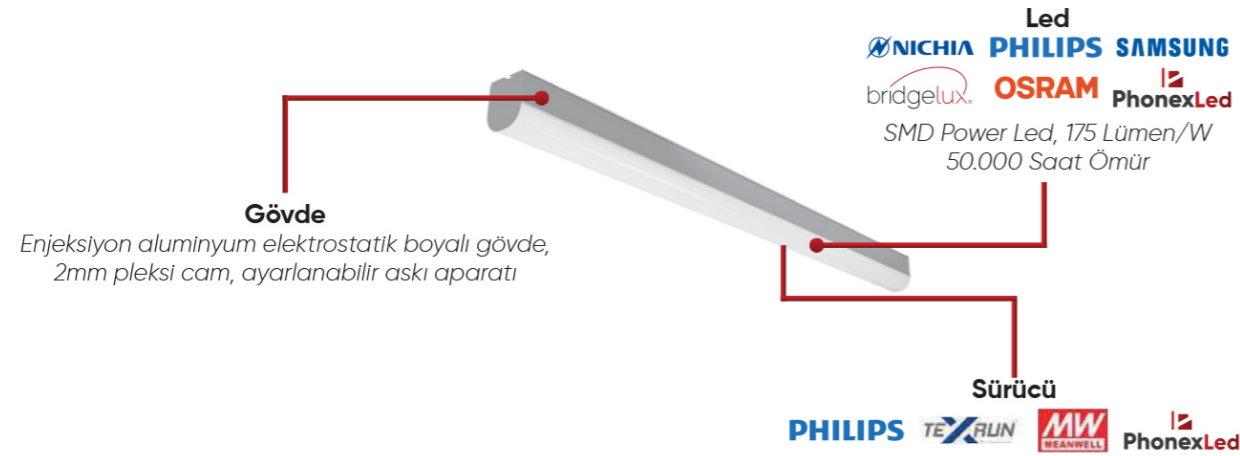

PHX-202/1

Güç : 50 W + 25 W LED
Ebat : 100 x 400 cm
Malzeme : Alüminyum

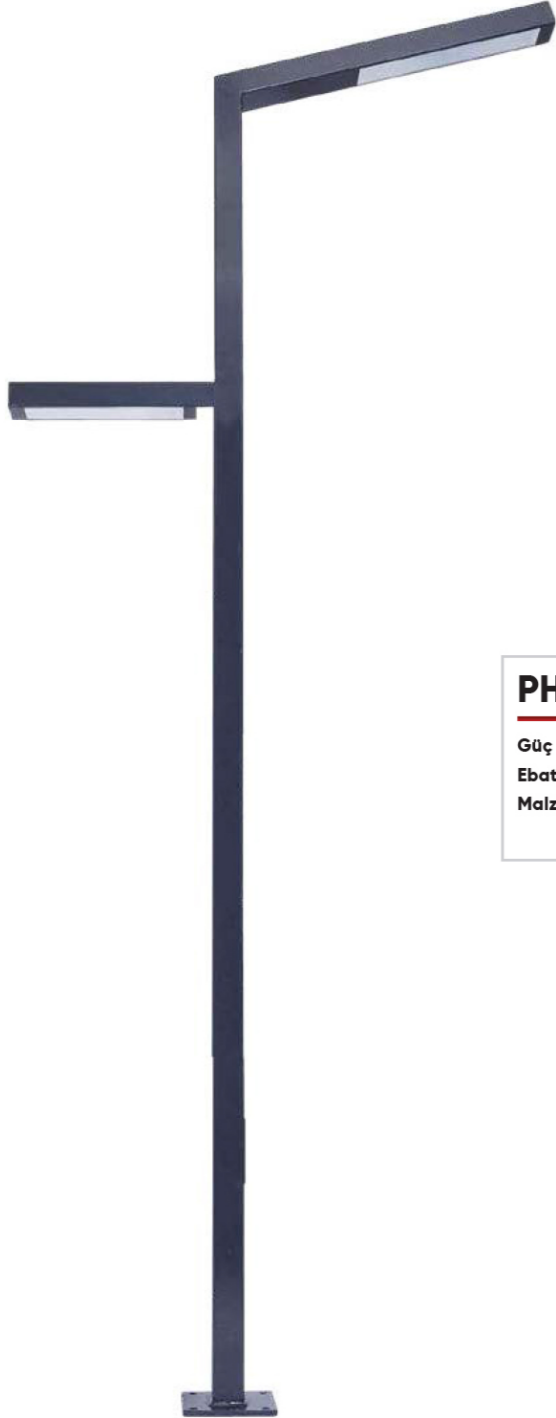
**PHX-202/2**

Güç : 2 X 50 W LED
Ebat : 120 x 400 cm
Malzeme : Alüminyum

**PHX-202/3**

Güç : 15 W LED
Ebat : 38 x 100 cm
Malzeme : Alüminyum

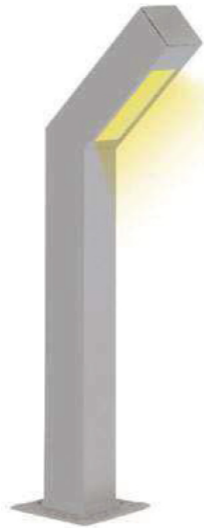
**PHX-203/1**

Güç : 60 W LED
Ebat : 70 x 350 cm
Malzeme : Çelik Boru + Alüminyum
 Profil

**PHX-204/2**

Güç : 60 W LED
Ebat : 40 x 350 cm
Malzeme : Çelik Boru + Akıllık Cam

**PHX-205/2**

Güç	: 50 W LED
Ebat	: 90 x 375 cm
Malzeme	: Çelik Boru + Pleksi ya da Lazer Kesim RGB LED

**PHX-205/3**

Güç	: 50 W LED
Ebat	: 75 x 390 cm
Malzeme	: Çelik Boru + Pleksi ya da Lazer Kesim RGB LED

**PHX-209/1**

Güç	: E-27 DUY ya da LED
Ebat	: 100 x 450 cm
Malzeme	: Çelik Boru + Alüminyum Şapka, Akıllık Cam,

**PHX-233/1**

Güç : 2 X 50 W LED
Ebat : 120 x 350 cm

**PHX-233/2**

Güç : 50 LED
Ebat : 60 x 350 cm

LENS AÇILARI



www.cbateknoloji.com



**CBA TEKNOLOJİ
AYDINLATMA ÜRÜNLERİ ÜRETİMİ VE
DANIŞMANLIK A.Ş.**

Atatürk Mah.Ertuğrul Gazi Sk.
Metropol İstanbul A Blok No:2E/331
Ataşehir / İSTANBUL

Tel : 0216 709 11 92
Fax : 0850 522 34 03

info@cbateknoloji.com

